

# **FTR** HANDBOOK *of* **TUBE OPERATION**

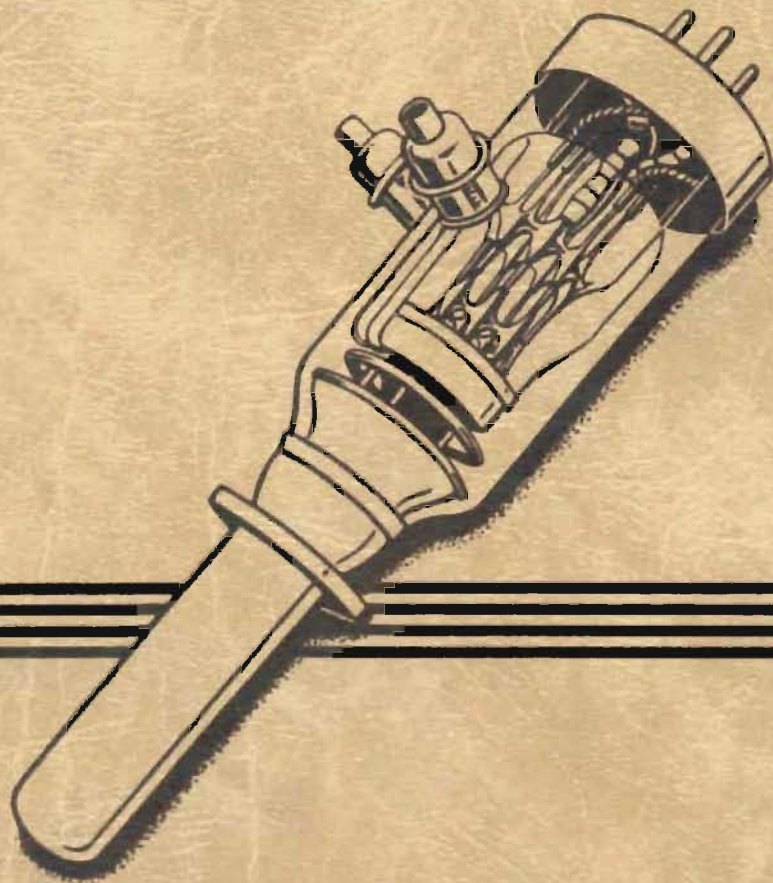

*Federal Telephone and Radio Corporation*



Newark 1, N. J.



**HANDBOOK**  
*of*  
**TUBE OPERATION**  
(SECOND EDITION)



***Federal Telephone and Radio Corporation***

**NEWARK,**



**NEW JERSEY**



Copyrighted 1944

***Federal Telephone and Radio Corporation***

NEWARK,  NEW JERSEY

Printed in U.S.A.



# Introduction

The popular, ever-widening appeal of the FTR *Handbook of Tube Operation* has been due, in large measure, to the simplicity of its descriptions, its great practicality, its factual content, and absence of the essentially theoretical. These qualities have resulted in raising an ordinary industrial treatise to the stature of a standard technical reference work.

The Federal *Handbook of Tube Operation*, of which this is the second edition, is designed to assist readers who would study the problems relating to the efficient and satisfactory operation of tubes in service. Its purpose is to develop a broader technical understanding of Transmitting and Rectifying Tubes, their characteristics, functions, applications.

Federal Telephone and Radio Corporation, now on the threshold of its 37th year, has pioneered in the development and manufacture of vacuum tubes since the earliest days of the industry. It is a matter of record that Federal's contributions to research, design, engineering, method and performance, especially during the war, have achieved the distinction of international recognition.





# LONGER TUBE LIFE

**LONGER** tube life means lower tube costs.

Find a way to increase the useful life of tubes in your equipment and the unit cost per hour of operation drops accordingly.

Many factors enter into the life of tubes. Of these the following are most apparent:

1. Filament voltage
2. Plate voltage
3. Operating temperature
4. Amount and nature of residual gas in tube
5. Number of times current is turned on and off
6. Fatigue of metal parts

## FILAMENT VOLTAGE VS. FILAMENT LIFE

Fortunately the first mentioned factor, that of filament voltage, can be controlled. As illustrated by the curves on the following page an extremely small change in filament voltage results in a considerable change in filament life. The possibility of increasing tube life by reducing filament voltage and consequently filament temperature is the result of the fact that bright tungsten filaments may be operated at complete saturation. In other words peak currents amounting in value to the total emission available may be drawn continuously without damage to the filaments.

Obviously, the curves show theoretical filament life based on normal evaporation of filaments and apply to bright tungsten filaments such as are generally used in water cooled tubes. While they may not hold for every installation the ratios or relationships may be considered an average for a large number of tubes.

Note that the increase in life obtainable is considerable even at slightly reduced filament voltages. For the same reason a correspondingly large reduction in life results from even slightly increased filament voltages.

## ACTUAL SAVINGS MADE POSSIBLE

This may be shown in still another way and will serve to point out the savings made possible by reducing filament voltages.

	Filament Voltage	Total Hours of Useful Life	Unit Cost Per Hour
	90%	400%	25%
	95%	194%	52%
Normal	100%	100%	100%
	105%	50%	200%
	110%	26%	415%

In other words, let us take a typical example. Let us suppose a tube has a rated filament voltage of 20 Volts and theoretical average life expectancy of 4000 hours. Let us assume further that the tube costs the station \$400.00. If the tube were operated with 20 Volts on the filament the life expectancy would be 4000 hours and the cost of operation would be ten cents per hour. Now let us assume that this same tube could be operated at 90% of the rated filament voltage. The theoretical average life expectancy would be increased to 16,000 hours and the unit cost of operation would be reduced to two and one half cents per hour.

Tubes are designed to provide a certain amount of emission at certain input voltages. Obviously, if the whole amount of emission designed into the tube is not required it becomes possible for the user to obtain more than the life expectancy provided for in the design of the filament.

For the same reason as shown by the curves an increase in tube life resulting from a decrease in filament voltage must be accompanied by a decrease in the available emission. The relationship of emission and theoretical filament life appears in the curves. Reductions in filament voltages, therefore, are recommended only in conjunction with reliable distortion measurements because of the possible flattening of positive peaks.

## THORIATED TUNGSTEN FILAMENTS

In the case of thoriated tungsten filaments such as are commonly used in transmitting tubes of intermediate sizes, these are operated at temperatures of such degree that evaporation is negligible. This means that the life of the tube is not controlled by the reduction of the tungsten wire and cannot be extended by operation at reduced voltage as in the case of the water cooled tubes.

In thoriated tungsten filaments the source of emission is a layer of thorium on the filament surface. During operation the thorium in this layer is constantly being removed by evaporation and bombardment and is constantly being replenished from within the wire. In order to maintain the balance between the loss and replacement of an active layer of thorium, therefore, requires operation within a comparatively narrow range of temperature.

Unusually short life may result, from the operation of thoriated filaments much below or much above rated values. In consequence, it is essential that the filament voltage be maintained at all times within the specified tolerances provided in the ratings of the various types of tubes.

This is highly important in the prolongation of the life of these tubes. Within the narrow range of temperature just mentioned the emission available is quite critical with respect to filament voltage. This is seen in the fact that a reduction of only 1% in voltage causes a loss of approximately 5% in emission.

Unlike bright tungsten filaments, thoriated tungsten filaments should never be operated at or near saturation. In other words, the peak currents drawn should not exceed more than one half of the maximum of which the filament is capable of emitting. These filaments are, therefore, designed to provide at least double the emission that would be needed in any normal class of operation.

## MERCURY VAPOR TUBES

Mercury vapor rectifier tubes with oxide coated filaments are designed to operate at specific temperatures. Here again very short life may result from operating these tubes either hotter or colder than the temperature specified. In order to get the most out of these tubes, therefore, it is essential that the filament voltage be maintained within the range specified for any given type.

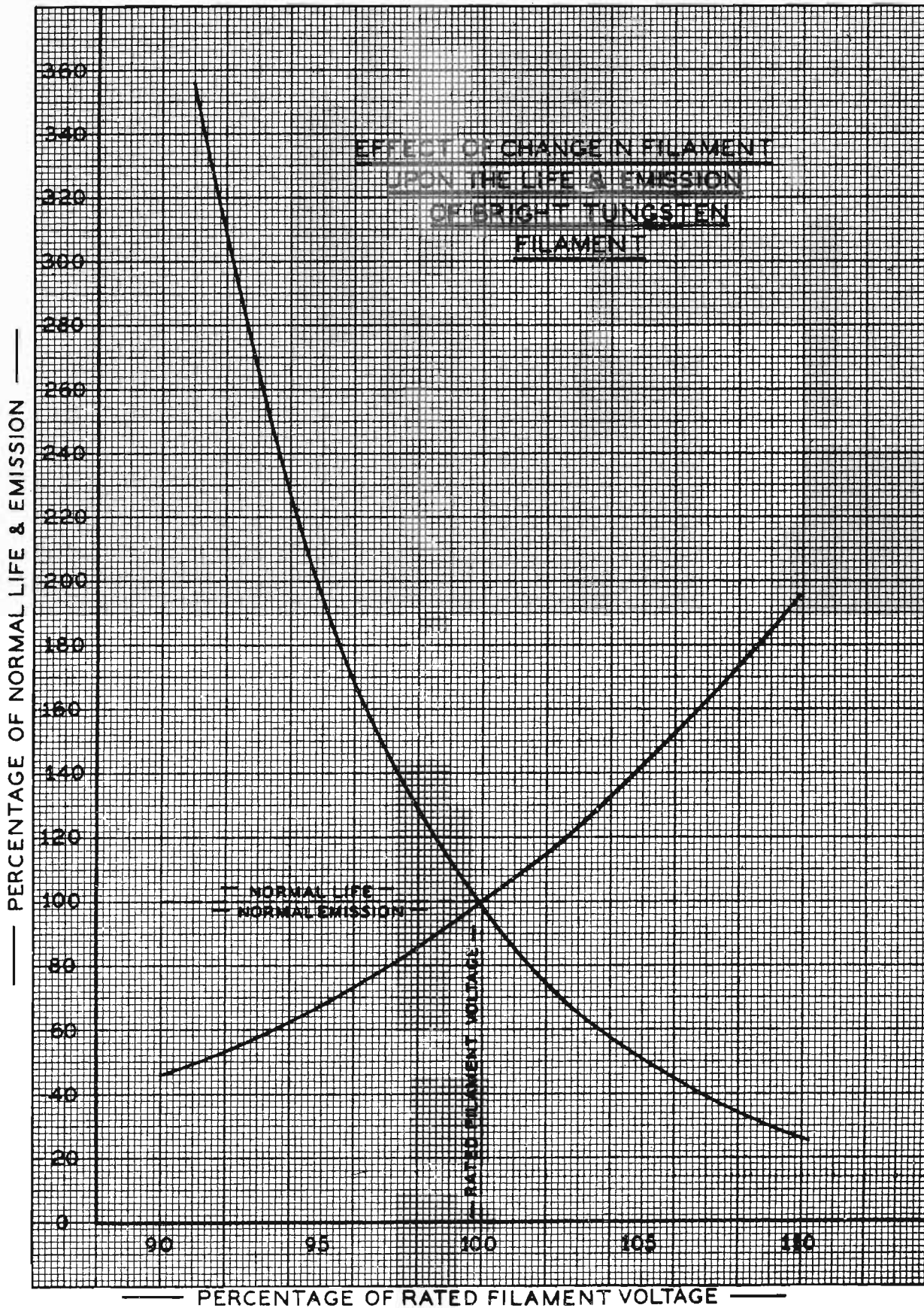



# SECONDARY EMISSION

in

## TRANSMITTING TUBES

### INTRODUCTION

SECONDARY emission in many instances has a definite bearing upon station operation. Since this phenomenon taking place inside the tube reacts in such cases upon the transmitter circuit, it cannot be wholly ignored by the engineer in charge. The purpose of this brief summary, therefore, is to describe secondary emission in its relation to the problems of the engineer who is striving for maximum efficiency in his equipment.

#### WHAT IS SECONDARY EMISSION

Described in the simplest terms, secondary emission may be defined as the ejection of electrons from either a metallic or non-metallic body resulting from the impact of bombarding electrons impinging upon and entering its surface.

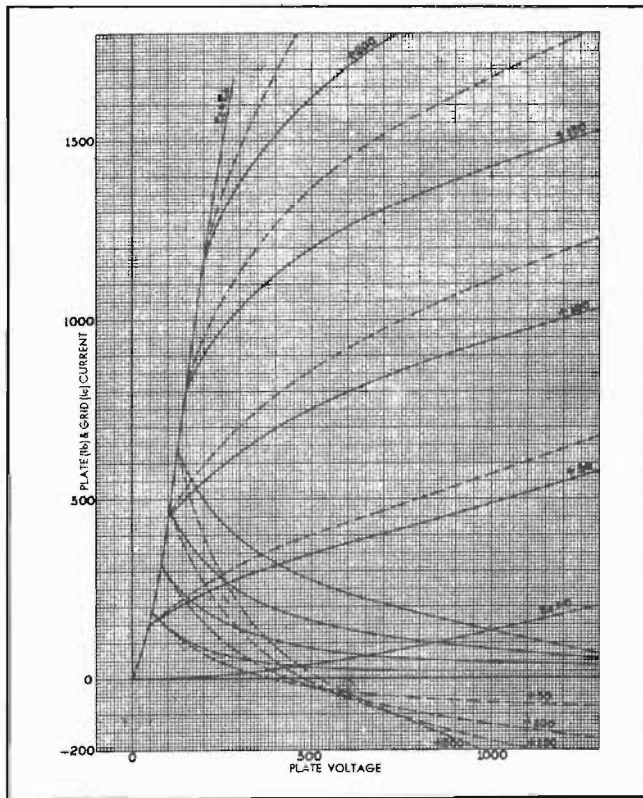

Fig. 1

Illustration of Variation of Vacuum Tube Characteristics by Grid Secondary Emission

———— indicates tube with low secondary emission  
----- indicates tube with very high secondary emission

Secondary emission occurs for impinging electron energies of approximately 10 volts or more. Its intensity increases from a minimum at this voltage to a maximum at 500 to 600 volts for most materials. While the ratio of the number of secondary electrons to primary electrons

may be much less than unity for impinging electrons of low energy, it may be as high as 10 for bombarding electrons of 500 volts. The mean energy of the emitted electrons is very much lower than that of the primary electrons, attaining a maximum value of approximately 10 volts for high energy primaries.

It is interesting to note that secondary emission characteristics are not affected by temperature so long as there is no physical transformation such as crystal structure change, film evaporation, etc., resulting from temperature conditions. Incidentally, the angle of incidence of impinging electrons results in a considerable variation in intensity of secondary emission.

#### EFFECTS ON TUBE CHARACTERISTICS

While the effects of secondary emission on tube characteristics and design are even more important in tetrodes and pentodes, a description of these effects in the case of triodes will serve as a satisfactory example.

As stated previously, secondary electrons may be emitted from either a metallic or non-metallic body. Consequently, in triodes these may be emitted from either the plate or grid structures and in some instances from the glass envelope or other insulating material. From a practical standpoint, consideration need be given in this case only to secondary emission from the electrodes and even this becomes of importance only when the electrode potential differences are such as to cause secondary emission currents to flow.

In the case of a diode, for example, while secondary emission may occur from the plate, the high positive potential of the anode with respect to the cathode prevents any of the low energy secondary electrons from escaping. Thus in the diode the net result is simply a negligible lowering of the effective anode potential by the negative space charge due to the bound secondary electron cloud.

This is very different, however, in a triode when secondary emission is flowing from the positive plate. In this case a secondary electron current will flow from the positive plate when the grid is at a higher positive potential, altering considerably the normal grid current distribution. Since in normal operation as an oscillator or amplifier the grid seldom becomes positive with respect to the plate, this condition is of interest only in dynatron oscillator or "frequency multiplier" operation.

# HANDBOOK OF TUBE OPERATION

Secondary emission currents are of considerable importance, however, in the normal operation of a triode in the positive-grid region of the tube characteristic. Here the grid may become considerably positive simultaneously with a higher positive plate potential when all secondary electrons from the grid will be drawn to the plate, thus increasing the normal current to the latter and decreasing that to the former. This condition is illustrated by the accompanying curves (Fig. 1).

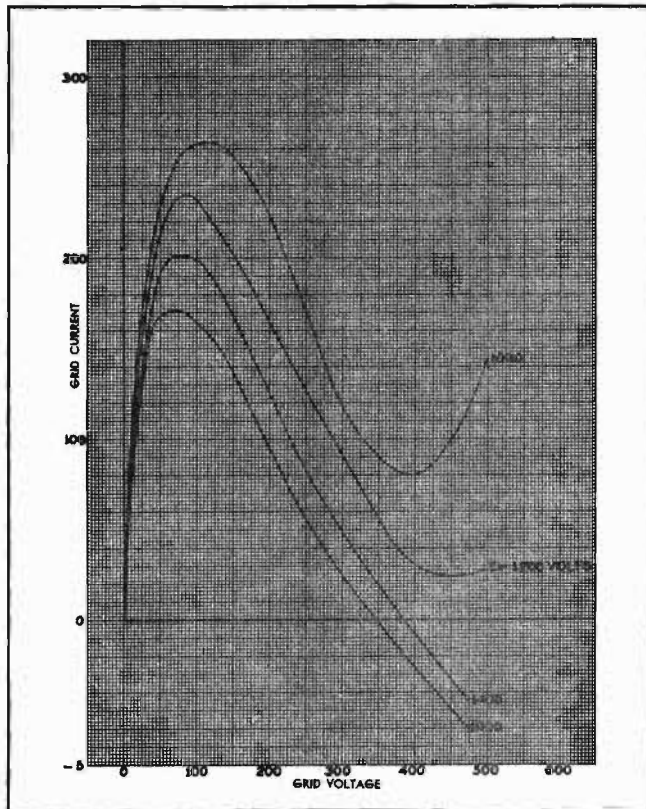

Fig. 2

Grid Characteristic of Vacuum Tube with Secondary Emission

Obviously when the grid potential is negative with normal plate current flow to the positive plate, no secondary emission from the grid will occur and as in the diode, the net effect will be that due to a slight negative space charge produced by secondary electrons at the plate. This latter effect as indicated previously is negligible in practice because of the extremely low energies of the secondary electrons. A glance at Figure 1, indicates that the grid secondary emission current to the plate may considerably alter the  $I_p$ - $E_p$  characteristics in the positive-grid region. In transmitting tubes the result is to increase the effective mutual conductance in the very vital region of high grid voltage and relatively low plate voltage, i.e., at the positive peak of the grid drive voltage swing and the negative peak of the plate voltage amplitude. This tends to compensate for the normal "crowding effect" due to saturation at this point.

Simultaneously with the above effect a corresponding reduction of the instantaneous grid current occurs in this region. The algebraic difference between the instantaneous current drawn by the grid with and without secondary emission is equal to the net plate current increase. The

grid current reduction may become appreciable by current passing through negative values over an appreciable part of the operating cycle, thus producing only a low positive or even negative net direct grid current flow.

## MANUFACTURING PROBLEMS ENCOUNTERED

It has been definitely established that secondary emission may be greatly influenced by the materials used and methods of manufacture.

Impurities in the metals employed, contamination by low work-function surface films such as alkalis, etc., improper bombardment and heat treatment on exhaust or oscillation are problems faced constantly in the manufacture of these tubes. Consequently, unless these factors are kept under constant scrutiny and properly controlled by the manufacturer the grid characteristics and to a comparatively minor degree the plate characteristics of a given type of tube may vary considerably.

Thus is the absolute necessity for uniform production procedure emphasized particularly when the manufacturer is called upon as frequently happens to supply tubes of matched characteristics.

Another characteristic inherent in grid secondary emission is the redistribution of electrode dissipation within the tube. While the grid current may be appreciably reduced or even negative in amplitude due to the secondary electron flow to the plate, the dissipation on the grid remains essentially that due to the initial primary current. This is due to the fact that the cooling effect on the grid of the emitted secondary electrons is negligible due to their extremely low energies as compared to the heating due to the impinging primary electrons from the cathode. This phenomenon must be taken into consideration in the grid dissipation rating of tubes designed for this type of service in order to avoid primary emission, i.e., thermionic emission from the grid, and possible melting of grid wire turns.

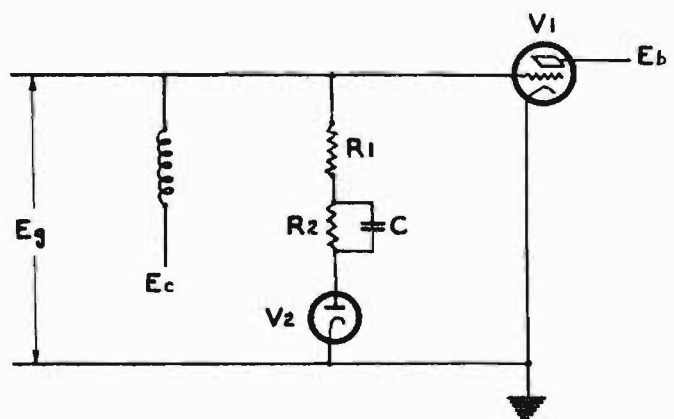

Fig. 3  
Dynatron Rectifier

Still another effect of secondary emission but originating from the above mentioned emission of secondary electrons from insulating materials is the possible "hot spotting" of the glass tube envelope. Stray electrons impinging upon the inner surface of the glass envelope may produce such emission of secondary electrons as to induce a positive potential at that point with subsequent increase of attracted

electron current. This effect may become cumulative and the heat due to the energies of the bombarding electrons may become sufficient to melt the glass with consequent failure of the tube. It follows, therefore, that transmitting tubes must be carefully designed so as to shield the envelope and other inactive surfaces from such stray electron bombardment.

## INFLUENCE ON TRANSMITTER CIRCUIT

Among the advantages of secondary emission is the reduction of instantaneous grid current values. This obviously produces a corresponding reduction in the required drive power for a given power output. This follows immediately from the expression for grid excitation power of radio frequency amplifiers and oscillators as developed by Thomas<sup>1</sup>,  $P_g = E_g I_c$ , where  $E_g$  is the peak value of the AC driving voltage and  $I_c$  is the average value of the grid current.

It should be noted in passing that in calculating grid excitation power by the Wagener<sup>2</sup> method in which  $P_g$  is taken equal to the maximum average grid current value times the peak drive voltage, an apparent value higher than that obtained by the Thomas method is given. This is due to the fact that the secondary emission effect is normally of less intensity at the extreme upper end of the dynamic characteristic, i.e., at the minimum attained plate voltage. In consequence, in taking the peak instantaneous current and not the average value integrated over the entire drive cycle, the negative regions of grid current are not taken into account.

At the same time grid secondary emission can have very serious detrimental effects upon a radio circuit since por-

tions of the Ig-Eg characteristic (Fig. 2) present an effective negative resistance to the exciting circuit. Unless this circuit is inherently very stable, such a negative resistance will require special circuit design to suppress the excitation of undesired spurious oscillations.

Thus in the case of radio frequency amplifiers, normal practice in transmitter design is to incorporate a damping resistor or network in the grid of the driven tube or the plate circuit of the driver. Such a damping resistor shunted across the grid circuit may involve an appreciable rise in excitation power required since power is absorbed over the entire driving cycle. In order to avoid this necessity the so-called "dynatron rectifier"<sup>3</sup> (Fig. 3) has come into use. This device, since it conducts only over the positive portion of the grid voltage cycle, involves considerably less loss with the same compensation of the secondary emission negative grid resistance.

Another result is the possibility of serious distortion which may be introduced in class B audio frequency amplifiers by secondary emission from the grid. Unless the effective series impedance of the grid driving circuit is made sufficiently low for frequencies considerably higher than the maximum to be amplified, the voltage drop due to the flow of grid current will introduce high odd harmonic grid voltage components and corresponding distortion of the output. This is very much aggravated where grid secondary emission is pronounced, as in the tube characteristic shown in Fig. 2.

(1) H. P. Thomas, *Proc. I.R.E.*, Vol. 17, June 1929

(2) W. C. Wagener, *Proc. I.R.E.*, Vol. 25, January 1937

(3) G. W. Fyler, *Proc. I.R.E.*, Vol. 23, September 1935

# WHY MAXIMUM RATINGS for TRANSMITTING TUBES

## INTRODUCTION

**M**AXIMUM ratings for tube operation are established solely with an eye to utmost in performance and long useful life.

Contrary to oft expressed belief, they are not arbitrary figures set up by the manufacturer to avoid answering legitimate questions by users. They are the result of careful analyses and, if properly understood, can be used by the transmitter engineer to decided advantage.

### WHAT ARE MAXIMUM RATINGS

First of all, maximum ratings do not represent the full capabilities of the best tube made. Quality in production and deterioration on the shelf must be considered. Almost every engineer at some time or other has set up an experimental circuit with a tube operating satisfactorily only to find that another tube of the same type failed to do so under identical conditions. That individual tubes will operate satisfactorily with long life in excess of the manufacturer's ratings simply serves to prove the case in point.

*Maximum ratings are those within which all tubes of a given type should give satisfactory operation and long useful life. Why they are necessary at all and how they are reached will be covered as briefly as possible in these pages.*

Amplifier Operation	Typical Value of 1PK/1DC	Max. Value of 1PK/1DC
Class B-AF or Unmodulated RF	3.14	3.14
Class B-RF Modulated 100%	6.28	6.28
Class C-RF Unmodulated	5	—*
Class C-RF Modulated 100%	8	—*

Fig. 1

*Relations between Peak and Direct Plate Current for Various Classes of Tube Operation*

\*Refer to Fig. 2, showing 1PK/1DC versus Operating Angle

### MAXIMUM PLATE VOLTAGE RATING

In water cooled tubes we must consider first of all the highest instantaneous voltage which may be impressed safely between the plate and the other elements.

Fundamentally, this value would be the voltage at which spurious emissions either from soft-x-rays or of spontaneous origin become apparent. Actually, however, because no such thing as a perfect vacuum and otherwise perfect condition of the internal parts is possible, the real value is lower than the theoretical limit. The extent

of reduction depends upon the tube geometry, the type of service for which it is intended and various other considerations.

Having arrived at this peak value it becomes necessary to know the ratio of crest to DC voltage, since the relationship between crest voltage during RF and AF cycles and the DC value varies with different classes of operation as does the maximum permissible DC plate voltage.

For example, in 100% modulated Class C operation, since the instantaneous applied crest plate voltage rises to twice the DC plate voltage under carrier conditions the maximum permissible value of the latter must be reduced to provide safe operation.

If it should be necessary to operate at plate voltages in excess of the maximum where the exact conditions of operation are known, an estimate of the effect of the plate voltage swing added to the DC supply value will indicate the relative safety of such procedure.

### MAXIMUM PLATE CURRENT RATING

The fundamental limitation on plate current is, of course, the total emission available from the filament. In water cooled tubes where the filament is bright tungsten the total emission may be considered as available. In this case, the limit is determined by satisfactory operation since no sacrifice in life results from drawing saturation currents. In fact as pointed out in Issue Number One of TUBES, maximum life is obtained by operation at filament saturation.

The total emission variation from tube to tube is the only variable that requires careful consideration in fixing the crest value of the current to be drawn. It should be pointed out, however, that in normal operation maximum grid and plate currents are drawn simultaneously, which means that allowance must be made for the former.

There is a definite relationship between the maximum instantaneous current value and the average DC plate current which differs for each class of operation (Fig. 1). This relationship depends upon the operating angle (usually expressed in electrical degrees) or portion of the cycle during which plate current flows. In Class B service the angle is fixed for all cases at approximately 180 electrical degrees but in Class C operation it may vary from this value to only a few degrees in width. The curve

in Fig. 2 shows the relation between peak conducted current and average DC plate current for reference in analysis of Class B or C tube applications.

## MAXIMUM PLATE DISSIPATION RATING

The plate dissipation rating of water cooled tubes is so dependent upon conditions outside of the tube proper and beyond the control of the manufacturer that it might almost be said to be fairly arbitrary, based as it is nevertheless upon the effective anode area. Even though a material of high thermal conductivity such as copper in most cases is used for the anode, practically no cooling is effective outside the area directly bombarded by electrons. This is roughly the projected area of the filament on the anode. (Fig. 3.)

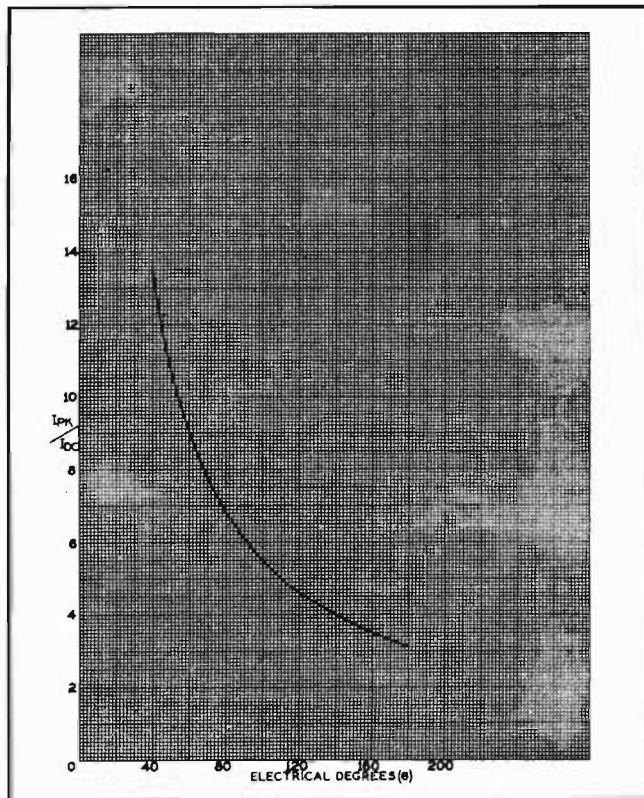

Fig. 2  
Ratio of Peak to DC Current versus Operating Angle.

Since the configuration of the internal elements is not readily observed and inasmuch as it will vary considerably in different types of tubes, the outside overall anode dimensions cannot be relied upon solely as a basis for determining the possible plate dissipation. Most water cooled tubes have anodes of such small area that the temperature would rise to dangerous values from filament heat alone if operated without a proper water cooling system.

Because of limitations in the thermal conductivity of water, satisfactory cooling is dependent upon the velocity of the stream flowing over the anode and not upon the amount of water surrounding it. A striking fact is that the effect of water used in cooling the tube is negligible as little as one eighth of one inch removed from the anode.

It follows that any scale formation on the anode itself will reduce its ability to dissipate heat, resulting both from

the fact that the scale is a poor conductor and that its comparatively rough surface tends to break up the smooth sheet of water flowing over the anode and creates pockets where localized boiling may occur.

The effective plate dissipation is taken as the integration over a complete RF or AF cycle of the instantaneous power dissipated by the anode. The thermal capacity of the anode must be sufficient to accomplish this averaging of dissipation peaks. Rated maximum plate dissipation given for carrier conditions will depend upon the type of operation and degree of modulation. Thus, since in Class B linear operation maximum anode loss is attained with unmodulated carrier, the maximum permissible effective plate dissipation rating for the tube applies. On the other hand, in Class C plate modulated operation where maximum plate loss obtains under 100% modulation, the maximum plate dissipation rating at carrier is only 66% of the maximum effective anode dissipation capability of the tube.

## MAXIMUM GRID CURRENT RATINGS

The limitations placed upon DC grid current are primarily for the purpose of avoiding excessive heating of the grid structure. Unfortunate though it is, the design of a grid is a necessary compromise between its primary function of providing an electrostatic field of a given strength, polarity and location in the electron stream between cathode and anode and the secondary function of receiving and dissipating the heat from electrons during its positive swings.

A grid providing the best tube characteristics would not be ideal from the standpoint of heat dissipating qualities. Although the fundamental limitation is in terms of watts dissipation the current value is used because it can be observed more readily. From the curves of a given tube we know how much voltage is required to obtain a given current value under any given set of operating conditions. Hence, if we take secondary emission effects into consideration the grid dissipation is known in terms of DC grid current. In addition, the maximum grid and maximum plate current must be considered together in their relation to the total emission.

The RF grid current limitation is often ignored. At low frequencies such may be considered safe practice as the currents likely to be encountered are well below the basis of design of water cooled tubes. As frequencies are increased, however, it becomes necessary to pay more attention to the  $I^2R$  loss in the grid lead. In the absence of convenient measuring facilities, observations of the copper to glass seal may serve as an indication of safe operation. A marked change in the color of the seal itself would indicate excessive heating from high current or from poor electrical contact to the external connection.

## THORIATED FILAMENT AIR COOLED TUBES

While the foregoing applies generally to water cooled tubes with tungsten filaments, additional considerations apply when we consider air cooled tubes using thoriated filaments.

One obvious factor is that plate voltages are limited to lower values because of the necessarily closer spacing of the elements in the tube and the greatly reduced distances

# HANDBOOK OF TUBE OPERATION

between terminals. The most important consideration is the fact that the thoriated filament is much more sensitive to positive ion bombardment than the bright tungsten filament. There is no such thing as a perfectly gas free vacuum tube. Consequently, the residual molecules of gas are ionized by collision with the electrons flowing to the plate, resulting in the production of positive ions which are accelerated toward any element that is negative with respect to the anode. Some of these will, therefore, strike the filament and depending on their number and velocity will tend to destroy the thin film of thorium from which the filament derives its emission.

As the velocity varies with the potential difference it is obvious that higher plate voltages increase the likelihood of impaired emission.

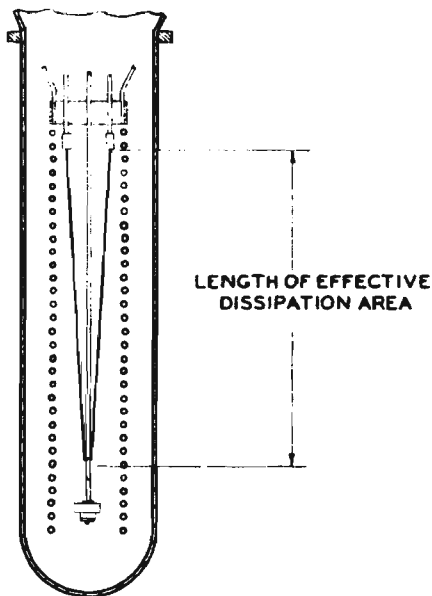

Fig. 3  
*Cross-section of Typical Water Cooled Triode.*

Of secondary importance are the limitations imposed upon the voltage by the insulating spacers commonly used as part of the structure of these tubes. Such limitations are, of course, dependent upon the dielectric strength of the insulating material, upon the creepage distance and the operating temperatures.

A marked difference in the selection of a maximum plate current limit is evident between bright tungsten filament and thoriated tungsten filament tubes. While the former may be safely operated with peak currents equal to the total emission, this is not good practice with the

latter. Here the available emission should not be taken as more than one half of the measured total emission.

While bright tungsten emission is a fixed value depending upon the area and temperature of the filament, the emission from a thoriated filament may vary widely even in the same tube in the course of its useful life and it is not necessarily true that the filament with the highest initial emission will have the longest life. These considerations lead to the explanation of the fact that an experimental set-up can be made where performance far above tube ratings appear to be perfectly satisfactory while as previously mentioned other tubes of the same type under the same conditions give poor performance or life. Such tubes are not necessarily defective since their performance may result simply from normal variations in production. Most important is that they serve to emphasize the inadvisability of basing designs on experiment rather than upon the manufacturer's ratings.

In air cooled tubes, the plate dissipation limitations are based almost entirely on considerations within the tube. Assuming that adequate air circulation is provided for external cooling of tube envelope and seals, the design, material and processing of the anode itself control the amount of wattage it is capable of dissipating. Mere observation of the color of the plate is not a safe indication upon which to base safe dissipation values. The material used and especially the processing in manufacture are such important factors that two plates of apparently identical design might safely operate at widely different temperatures.

There is no material or process known today that can provide a plate completely free of gas. What is done is the outgassing of the plate to a given maximum condition. It may then be assumed that in subsequent operation below that condition gas evolution will be of such negligible proportions as to do no harm.

An important point which may well be stressed in operating plates at high temperatures is the fact that these will radiate heat inward as well as outward and although the plate itself will be able to withstand excessive temperature without damage or excessive gas evolution, the heat radiated to the grid and filament may overheat these latter to the extent of damaging the grid or causing the filament to run at a temperature outside of its designed operating range.

The same considerations given to RF and DC grid current in water cooled tubes may be applied generally to air cooled tubes excepting in the case of some of the older types of air cooled tubes which have grid lead seals designed for low frequency operation. The higher currents encountered in high frequency operation naturally require the use of tubes specially designed for the purpose.

# TYPICAL OPERATION DATA INCLUDING METHODS OF CALCULATION

## INTRODUCTION

**T**YPICAL operation data for transmitting tubes is published primarily as a guide in selecting tubes to meet specific power ratings. Moreover as a means of information to the transmitter engineer, typical operation data is invaluable for circuit and power requirement designs.

Wherever possible operation data conforms to general practice in the field. It also conforms with power ratings approved by the Federal Communications Commission. Operating conditions for a given tube are chosen so that the maximum ratings are not exceeded.

### CLASS B R-F POWER AMPLIFIER (Carrier conditions per tube for use with modulation factor up to 1.0)

Filament Voltage	20 volts
D-C Plate Voltage	17500 volts
D-C Grid Voltage	-430 volts (approx.)
Peak R-F Grid Input Voltage	760 volts (approx.)
D-C Plate Current	1.55 amperes
D-C Grid Current	0.021 amperes
Driving Power*	28 watts (approx.)
Load Impedance	2780 ohms
Power Output	8250 watts (approx.)

\* At crest of A-F cycle

Fig. 1. Typical Operation Data F-116-A Transmitting Tube

## DEFINITION OF TERMS

Values for typical operation data are usually tabulated as a matter of convenience for ready reference. A short definition of the terms used in connection with the value given is, therefore, probably in order.

**FILAMENT VOLTAGE.** The value given represents the voltage that should be maintained across the filament terminals of the tube. In certain cases as pointed out in Issue Number One of TUBES, the filament voltage may be reduced from the value given and increased life obtained. For air cooled tubes using thoriated filaments the voltage should not vary more than plus or minus 5%.

**DC PLATE VOLTAGE.** The DC voltage applied to the plate of the tube.

**DC GRID VOLTAGE.** The voltage applied to the grid of the tube. This value may be obtained by means of a grid leak resistor, a cathode resistor, a battery, a generator, or a combination of the above.

**PEAK RF GRID INPUT VOLTAGE.** The peak value of the radio frequency voltage that must be applied to the grid of the tube in order to obtain the output specified.

**PEAK AF GRID INPUT VOLTAGE.** The peak value of the audio frequency voltage that must be applied

to the grid of the tube in order to obtain the output specified.

**ZERO SIGNAL PLATE CURRENT.** The average value as read on a DC meter in the plate circuit of the tube when no signal voltage is applied to the grid of the tube.

**MAXIMUM SIGNAL PLATE CURRENT.** The average value as read on a DC meter in the plate circuit of the tube when a maximum amplitude signal is being constantly applied to the grid of the tube. The value of this signal voltage corresponds to the peak AF grid input voltage.

**DC PLATE CURRENT.** The average value as read on a DC meter in the plate supply circuit of the tube.

**DC GRID CURRENT.** The average value as read on a DC meter in the return circuit of the grid of the tube.

**DRIVING POWER.** The value of the radio or audio frequency power that must be applied directly at the grid of the tube in order to obtain the output specified. The driver stage should have good regulation and should be capable of delivering considerably more than the required driving power.

**LOAD IMPEDANCE.** The impedance necessary in the plate circuit of the tube for the values input and output specified.

**POWER OUTPUT.** The plate power output obtained neglecting circuit losses.

## METHODS OF CALCULATION

In order to calculate the performance of a transmitting tube characteristic curves of the tube in question are necessary. The most common curves published are plate and grid characteristics.

The plate characteristic curves are a family of curves showing the relationship between plate current and plate voltage with constant grid voltage. To make these curves suitable for calculations of other than Class A operation, the relationship in the region of positive grid voltage must be included.

The grid characteristic curves are a family of curves showing the relationship between grid current and plate voltage with constant grid voltage.

# HANDBOOK OF TUBE OPERATION

Another type of curve not usually published but obtainable by re-plotting the plate and grid characteristic curves is known as a constant current curve. This curve shows the relationship between grid voltage and plate voltage with constant plate current or with constant grid current.

A simple method of calculating Class B audio frequency amplifier operation data illustrating the use of the plate characteristic curves may be outlined as follows. Let Fig. 2 represent the average plate characteristics of a transmitting tube with the coordinates as shown at the constant grid voltages  $E_g$ . Then designate the plate voltage applied as  $E_b$  and the average value of plate current for one tube  $I_b$ . Furthermore let us choose a value of  $E_c$  such that the plate current  $I_b$  will be nearly zero at the plate voltage  $E_b$ , locating the point P in Fig. 2.

$$\text{Now } i_b \text{ max.} = \pi \times I_b$$

The point O can now be located on a line whose value is  $i_b \text{ max.}$  such that value of  $e_c \text{ max.}$  is equal to or less than  $e_b \text{ min.}$  If the value of  $e_c \text{ max.}$  is greater than  $e_b \text{ min.}$  there will be a dropping off of power output at the peak value. The value of the plate voltage swing is  $E_p = E_b - e_b \text{ min.}$  as indicated in the diagram (Fig. 2). Since the tube operates for only one-half of the cycle it is necessary that two tubes be used in a balanced push-pull circuit to obtain linear audio-frequency output.

The power output for two tubes then is  $P.O. = \frac{1}{2} i_b \text{ max.} \times E_p$ .

Power input for two tubes is  
 $P.I. = 2 \times I_b \times E_b$

$$\text{and efficiency} = \frac{P.O.}{P.I.}$$

The value of the load resistance per tube is in this case

$$R_L = \frac{E_p}{i_b \text{ max.}}$$

and the plate to plate load resistance  $4 \times R_L$ .

Grid driving power requirements are often limited by the regulation of the driver stage and the minimum grid impedance of the Class B amplifier, so that a close approximation of the necessary driving power is sufficient to determine the tubes needed for the driver stage.

The following procedure gives values of driving power which are adequate for the foregoing.

From Fig. 2 at point o we have the values of  $e_c \text{ max.}$  and  $e_b \text{ min.}$  Now, if we take the grid characteristic curves of the tube at values of  $e_b \text{ min.}$  and  $e_c \text{ max.}$  we find the corresponding value of grid current which we shall call  $i_g \text{ max.}$

The grid voltage swing  $E_g$  is the algebraic sum of the bias at point P ( $E_c$ ) and the grid voltage at point O ( $e_c \text{ max.}$ ).

$$E_g = -(-E_c) + e_c \text{ max.}$$

The grid driving power for two tubes is then

$$P_g = \frac{2}{5} \times i_g \text{ max.} \times E_g$$

## GRAPHICAL METHODS

While by employing a mathematical analysis it is possible to predict the power capabilities of a transmitting tube, the use of the plate and grid characteristic curves do

not lend themselves readily to graphical interpretation. If constant current charts are available results are more readily obtained.

The constant current curves show the relationship between the plate voltage and plate current with the grid voltage and grid current in such a way that an accurate determination can conveniently be made of the values of the power input, power output, grid voltage swing, grid current, average plate current and load impedance. Since both the grid and plate potentials are considered to vary as sine waves, every dynamic characteristic drawn on the curves is a straight line. The above values can be determined graphically

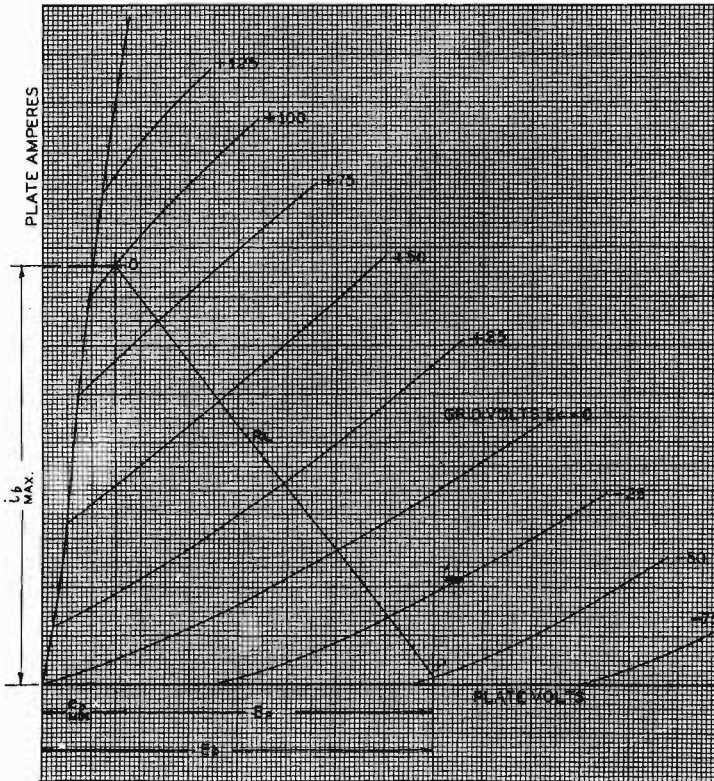

Fig. 2. Average Plate Characteristics

ically by extending a line from the operating point to the point where the maximum positive grid swing coincides with the minimum plate voltage. The operating point is determined by the bias chosen and the plate voltage. The minimum plate voltage is determined by how far the grid is allowed to swing positive and the value of the load impedance. The maximum grid swing, minimum plate voltage point is then located and the other unknown values can be found graphically. For determining the plate current and predicting the grid current it is necessary to integrate the values of current over a complete half cycle of the wave. To simplify the work of integration a scale graduated in the sines of the angles is useful.



## HARMONIC ANALYSIS

Several satisfactory methods are employed for predicting the harmonic distortion of the waves. These methods take into consideration that for no distortion the relation between plate current and grid voltage must be linear.

By plotting the plate current as a function of the grid voltage for the load impedance of the case of operation in question and measuring at predetermined points the ordinate differences between the plate curve thus obtained and a straight line joining the extremes of the plate curve, the harmonic distortion may be computed.

In the case of a modulated wave it is necessary to calculate the power output in steps from zero to 100% modulation and to plot the AC value of modulated current as a function of the grid voltage. By measuring at pre-determined points the ordinate differences between the modulated current curve and a straight line joining the ends of the modulated current curve, the harmonic distortion may be computed.

## EXPERIMENTAL METHODS

Typical operation data may also be obtained by experimental test. One method is to test the tube at 60 cycles using transformers. The DC grid voltage and DC plate voltage are obtained either from generators or batteries. Driving voltage is obtained from a transformer in the grid circuit of the tube. By suitable meters the average value of grid current, grid voltage and driving power may be

read. The plate transformer is connected  $180^\circ$  out of phase, to the same mains as the grid transformer. Power drawn from the plate generator or battery is transformed into alternating current power. The power output may be read by a wattmeter and the plate voltage and plate current by the required DC meters.

By making the alternating potentials and DC grid and plate voltages continuously variable, any condition of operation may be investigated.

For large transmitting tubes such as water cooled types, calculations from the curves of the tubes are more practicable inasmuch as the cost of the equipment for experimental observation is considerable. For air cooled types the experimental method is convenient and rapid.

## OPERATION DATA FOR SPECIFIC CASES

Very often it becomes necessary to determine operation data with specific conditions in mind. In some installations the plate supply voltage may be the limiting factor. At other times the driving power is fixed. For high quality application the harmonic distortion must be kept within certain specifications or to a minimum. Calculations will have to be repeated until the operation data will meet all conditions required at the same time, keeping in mind the limitations of the tube with respect to plate dissipation, plate voltage, plate current, grid current and RF grid current.

---

## BIBLIOGRAPHY

- E. L. Chaffee, "The Operating Characteristics of Power Tubes," *J. App. Phys.* 9, 471 (1938).
- E. L. Chaffee, "A Method of Obtaining the Static Characteristic Curves of Power Tubes," *Electronics*, June, p. 34 (1938).
- E. L. Chaffee, "Power Tubes Characteristics," *Electronics*, July, p. 30 (1937).
- W. G. Wagner, "Simplified Methods for Computing the Performance of Transmitting Tubes," *Proc. I. R. E.* 25, 47 (1937).
- J. A. Hutchison, "Graphical Harmonic Analysis," *Electronics*, Jan. p. 16 (1936).
- E. L. Chaffee, "A Simplified Harmonic Analysis," *Rev. Sci. Inst.* 7, 384 (1936); 8, 227 (1937).
- F. E. Terman and W. C. Roake, "Calculation and Design of Class C Amplifiers," *Proc. I. R. E.* 24, 620 (1936).
- I. E. Mouromtseff and H. N. Kozanowski, "Grid Temperature as a Limiting Factor in Vacuum Tube Operation," *Proc. I. R. E.* 24, 447 (1936).
- E. L. Chaffee and C. N. Kimball, "A Method of Determining the Operating Characteristics of a Power Oscillator," *J. Frank Inst.* 221, 237, (1936).
- W. L. Everitt, "Optimum Operating Conditions for Class B Radio Frequency Amplifiers," *Proc. I. R. E.* 24, 305 (1936).
- I. E. Mouromtseff and H. N. Kozanowski, "An Analysis of the Operation of Vacuum Tubes as Class C Amplifiers," *Proc. I. R. E.* 23, 752 (1935).
- B. F. Miller, "An Analysis of Class B and Class C Amplifiers," *Proc. I. R. E.* 23, 496 (1935).
- I. E. Mouromtseff and H. N. Kozanowski, "A Short Cut Method for Calculation of Harmonic Distortion in Wave Modulation," *Proc. I. R. E.* 22, 1090 (1934).
- F. E. Terman and J. H. Ferns, "The Calculation of Class C Amplifier and Harmonic Generator Performance of Screen-Grid and Similar Tubes," *Proc. I. R. E.* 22, 359 (1934).
- W. L. Everitt, "Optimum Operating Conditions for Class C Amplifiers," *Proc. I. R. E.* 22, 152 (1934).
- H. P. Thomas, "Determination of Grid Driving Power in Radio Frequency Power Amplifiers," *Proc. I. R. E.* 21, 1134 (1933).
- H. N. Kozanowski and I. E. Mouromtseff, "Vacuum Tube Characteristics in the Positive Grid Region by an Oscillographic Method," *Proc. I. R. E.* 21, 1082 (1933).
- J. R. Nelson, "Class B Amplifiers Considered from the Conventional Class A Standpoint," *Proc. I. R. E.* 21, 858 (1933).
- C. E. Fay, "The Operation of Vacuum Tubes as Class B and Class C Amplifiers," *Proc. I. R. C.* 20, 548 (1932).
- C. E. Kilgour, "Graphical Analysis of Output Tube Performance," *Proc. I. R. E.* 19, 42 (1931).
- E. E. Spitzer, "Grid Losses in Power Amplifiers," *Proc. I. R. E.* 17, 985 (1929).
- D. C. Prince, "Tubes as Power Oscillators," *Proc. I. R. E.* 11, 275, 405, 527 (1923).

# TUBE PROTECTION PROBLEMS

## PART ONE

### INTRODUCTION

THE nature of protective devices required by a specific piece of electrical equipment is determined (1) by the characteristics of the equipment itself, (2) by the type of service to be imposed, and (3) by the nature of associated equipment.

### PROTECTING TUBES

For obvious reasons, considerations of type of service and associated equipment will vary widely. These are at the same time expanding rapidly and changing constantly with the application of tubes in new fields. Nevertheless, the basic requirements of protection of tubes themselves remain the same.

While it is generally agreed that a vacuum tube or gas filled tube of proper design and careful manufacture should give trouble free operation and have a long life expectancy when operated within the maximum voltage, current and power ratings for a given type of tube and a specific application, it follows that operating conditions must be such that these maximum values are maintained closely and at no time exceeded.

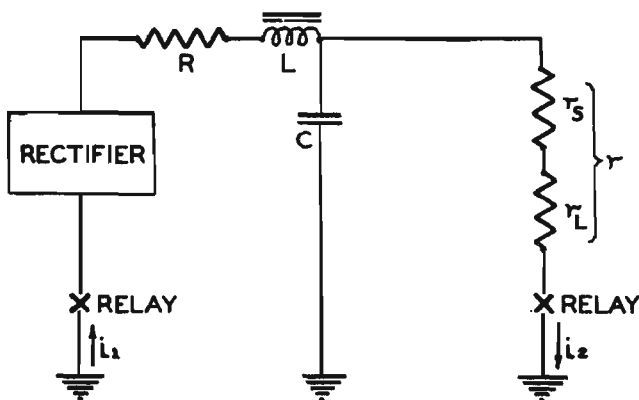

Fig. 1. Schematic of Typical Rectifier Plate Voltage Supply.

Tubes, either vacuum or gas filled, differ from most other pieces of electrical equipment in one major respect. In no case are they rated for overload operation as are, for instance, conventional motors, generators and transformers.

This is the result of certain engineering and design factors involved in manufacture. Consequently total emission, plate and grid dissipation and peak voltage drop, for instance, are fixed constants. They may not be exceeded for even short intervals of time without running the risk of bringing about either impaired characteristics or, worse still, complete failure of the tube.

Protection of tubes may, for the sake of convenience, be divided into three general considerations; namely, those applying to the plate, grid and filament circuits.

### PLATE CIRCUIT

Ranking first in importance is unquestionably the plate current overload relay. This is because most abnormal operating conditions are usually reflected in increase of the plate current and consequently plate dissipation. Even

a slight excess of plate dissipation, particularly in the case of water cooled tubes, may result in failure of the tube if maintained for a considerable interval of time. Thus it remains of vital importance to the safety of tubes in operation that overload relays and circuit breakers of proper design and providing positive and rapid removal of applied plate voltage be used.

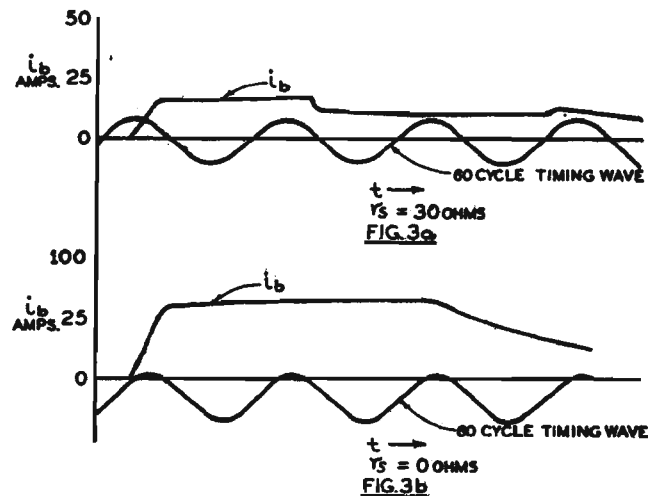

Short circuit load current surge from 3 phase full wave rectifier with (Fig. 3a) and without (Fig. 3b) surge current limiting series load resistance. (Oscillograph traces of load current,  $i_b$ , for circuit of Fig. 1 when  $L = 4.5$  H;  $C = 0.5$  MFD;  $R = 20$  Ohms.)

Next in importance only to a properly designed overload relay is proper placement of such relays in the circuit.

In power amplifiers, particularly those using water cooled tubes, high speed repeating-reset instantaneous overcurrent relays should be installed in series with the tube, either in the plate lead immediately adjacent to the tube or in the cathode ground return (see Fig. 1). In case of parallel or series parallel operation of at least the larger water cooled power amplifier tubes it is advisable to insert a relay in series with each tube or group of tubes since by this arrangement close adjustment of relay trip limits and sensitivity with consequent increased rapidity of circuit break are obtained. Such a relay arrangement serves also to give localized indication of tube failures.

The customary overload relay in the rectifier or generator ground return, while functioning to adequately protect the high voltage source as well as power amplifier equipment with conventional speed, may not furnish satisfactory protection of the amplifier tubes, depending upon filter network constants between power source and fault. This is particularly true in telephone transmitters where the filter reactances are ordinarily large. The effect of relay

sensitivity and placement in increasing the operating speed of the protective system is brought out by the curves (see Fig. 2), which show the time relation between currents  $i_1$  and  $i_2$  of a single section filter such as that of Fig. 1.

It is seen that the rate of rise and amplitude of current  $i_1$ , through the rectifier return, is considerably less than that of the load current  $i_2$ . Thus it is apparent that the action of a relay placed in the rectifier return will be considerably slower than that of one directly in series with the load.

The following formulae for  $i_1$  and  $i_2$  as plotted in Fig. 2 refer to the single section filter of Fig. 1, for  $L$ ,  $C$ ,  $R$  and  $r$  values corresponding to the critically damped case only as shown by the curves of Fig. 4.

$$(1) \quad i_1 = \frac{E}{R+r} \left[ 1 - K_1 (1 + rCm)te^{mt} + \left\{ K_2 + rC(mK_2 - K_1) \right\} e^{mt} \right] \text{ amperes}$$

$$(2) \quad i_2 = \frac{E}{R+r} \left[ 1 - K_1 te^{mt} + K_2 e^{mt} \right] \text{ amperes}$$

$$\text{where } K_1 = \frac{1}{rC} + mK_2$$

$$K_2 = \frac{R}{r+R}$$

$$m = \frac{1}{2CR} - \frac{R}{2L}$$

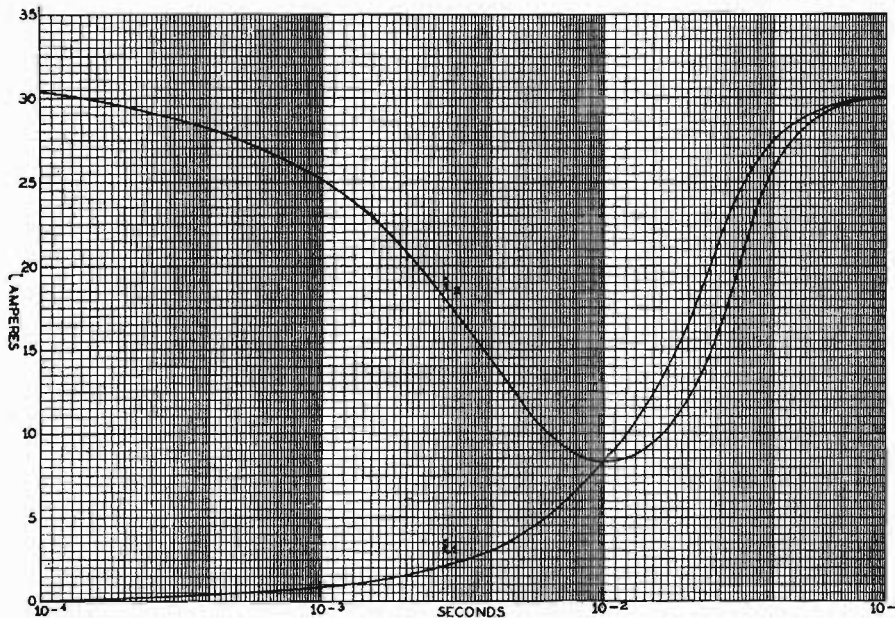

Fig. 2.

Curves showing relation between load ( $i_2$ ) and rectifier ( $i_1$ ), transient currents upon partial short-circuit of load for single section filter of Fig. 1, (critically damped case).  $L = 10$  henries,  $C = 10$  microfarads,  $R = 10$  ohms,  $r = 497$  ohms.

Formulae (1) and (2) are valid only for the critically damped case when

$$r = \frac{L}{2\sqrt{LC + RC}}$$

Mercury vapor rectifier tubes are adequately protected from short-circuit load currents by the customary DC overcurrent relay in the rectifier return and AC overload current relays in the plate transformer primary. Series surge resistance here also serves to limit transient currents in the case of flash back of the rectifier tubes themselves while the primary relays are relied upon to open the circuit, the speed of operation of the latter being normally insufficient to alone prevent destructively high tube currents. The combined action of the total series short-circuit resistance and reactance plus horn-gaps across the transformer secondary legs should be such as to limit the tube peak surge current to rated value.

Current limiting resistors in series with the plate circuit of tubes as shown in Fig. 1, by  $r_8$  may be used to limit flash arc and short-circuit surge currents to insure a safe value. In telephone transmitters the size of such resistors is usually limited by the allowable regulation of the plate voltage before appreciable distortion occurs. The oscillogram traces shown in Figs. 3a and 3b, demonstrate the effectiveness of such resistance in the protection of the water-cooled tubes of a high voltage test oscillator. Substantial increase of mercury vapor tube life as well as reduction of tube failures during test was effected by this installation.

Abnormally high peak voltages across tubes may be prevented by the connection of spark gaps adjusted for breakdown somewhat above the normal peak instantaneous operating voltage encountered between tube plate and ground. Series resistance is usually inserted to limit the breakdown current. The value of such resistance

should be less than the critical value for the circuit above which oscillatory conditions with consequent abnormally high voltage peaks may exist. Fig. 4, shows the relation between power supply  $L/C$  ratio and the critical value of series short-circuit load resistance  $r_2$ , for various values of internal power supply resistance  $R$ .

In the application of tubes to high voltage operation, precaution must be exercised when applying the plate voltage. In the case of operation of mercury vapor tubes in a rectifier at peak inverse voltages of 10,000 volts and greater, voltage should be applied either gradually as by means of a voltage regulator, or in one or more steps, or by a combination of these two methods. This is in order to minimize the danger of tube failure due to high transient starting voltages. A reduced plate voltage tap should be provided for test operation and adjustment of both tubes and transmitter.

## GRID CIRCUIT

While the grid circuit of transmitters generally is not protected by relays or other active elements, since abnormal grid voltages or currents usually are reproduced in an amplified degree in the plate circuit effectively actuating the protective elements, it is equally important that maximum values be observed here also for both steady state and transient conditions.

Thus if high voltage surges are likely to be impressed in the grid circuit, a spark gap, Thyrite or other low resistance surge path from grid to ground should be provided. Likewise, if the drive or bias supply voltage

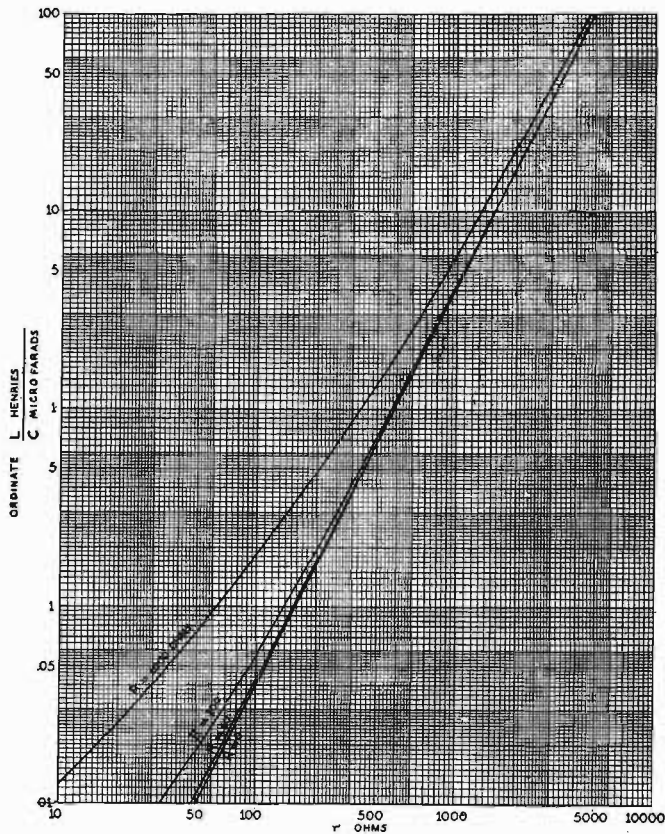

Fig. 4.

*Total Load Resistance,  $r$ , of Single Section Filter (as a Function of the L/C Ratio of Various Values of Total Series Power Supply Resistance, R) for Critically Damped Case, i. e., Below which no Transient Output Voltage Rise Occurs.*

and regulation are such as to maintain a high surge current in the case of a grid-filament flasharc, a current limit-

ing device should be used according to the requirements of the individual application. Here also high oscillatory transient voltages may be encountered between grid and cathode when using a bias rectifier if the bleeder resistance is above the critical value for the particular filter constants. (See Fig. 4.)

In general, it is advisable to keep the total grid-to-ground series resistance as low as possible, or in other words to maintain the grid as close to ground or negative bias potential as practical. This will prevent incipient flasharc or gas discharge currents from raising it to a high positive value. In this case, however, as already pointed out, a low impedance surge current path to ground should be provided, otherwise destructively high currents through associated circuit elements such as r.f. chokes, etc., may occur.

## FILAMENT CIRCUIT

The principal considerations with respect to the tube filament are the maintenance of the specified operating filament voltage and limitation of the starting filament current to a safe value to avoid strain or fracture of the filament strands.

The necessity of the first consideration in order to obtain the expected tube filament life has been dealt with in detail in an earlier issue of TUBES. Close regulation of filament voltage may be obtained by any of the standard methods such as primary voltage regulator, constant voltage transformer, or ballast resistor, but in such cases where fluctuation beyond plus or minus 5 per cent is liable to occur, protective time delay relays should be provided to remove or reduce filament voltage.

Starting filament current must be limited to twice the normal operating value or less. This may be accomplished by means of generator field control in the case of DC excitation, by inserted primary transformer series resistance or reactance or by the use of special high leakage reactance filament transformers.

The uninterrupted flow of cooling water in sufficient volume through the jackets of water cooled tubes must be maintained both when tubes are delivering plate power and when the filament power alone is to be dissipated. Relays operating to remove all transmitter and filament voltages upon inadequate flow of cooling water must be provided. In the same way, in the case of high voltage mercury vapor rectifiers operating under closely limited forced draft, maintenance of ambient temperature relays should be provided to insure proper air flow. In the case of large water cooled amplifier tubes it is advisable that a water flow relay be provided for each individual tube or branch of circuit.

# TUBE PROTECTION PROBLEMS

## PART TWO

### INTRODUCTION

**I**N part one, consideration was given to protection of tubes as related to the plate, grid and filament circuits. The subject would not be completely covered, however, without consideration of two remaining highly important phases of tube protection; namely, those relating to flash-arcs and to proper water cooling.

#### WHAT ARE FLASH-ARCS?

Flash-arcs, which give rise to the condition commonly called "Rocky Point Effect," fortunately are no longer as common in vacuum tubes today as was the case years ago. Obviously, this is the result of great progress made during recent years both in vacuum tube manufacturing technique and in transmitter circuit design. Nevertheless, since this phenomenon is definitely related to the operation and life of vacuum tubes, it follows that those employing these tubes should profit from an understanding of its nature.

The term "flash-arc" refers to an electrical discharge between the electrodes of a highly evacuated tube, usually between anode and grid or cathode. To the station operator the presence of a flash-arc is usually made evident by the sudden tripping of the DC overload current relay and circuit breaker without warning during normal operation of the transmitter. Since the arc may be entirely inaudible and practically invisible because of filament glare, detection is often difficult. No characteristic blue glow within the glass envelope such as accompanies the arcover of a gassy tube obtains, although spots of fluorescent light may be seen occasionally on the inner surface of the glass envelope during arcover. The random occurrence of such arcs, therefore, makes direct observation in the station rare.

While a similar phenomenon, known as "arcbreak," occurs in gas or vapor filled high voltage rectifier tubes causing breakdown of the cathode-anode space insulation during the non-conducting portion of the cycle, the term "flash-arc" commonly refers to the arc formed in high vacuum tubes. Furthermore, the term "flash-arc" refers properly to an arc of high voltage drop which establishes conduction initially across the evacuated space and not to a low voltage power arc resulting from the discharge of the power supply through the resulting conducting path.

While the flash-arc sometimes serves to establish the conduction path for a destructive power arc, of itself it is of insufficient energy to damage the internal tube struc-

ture. Dependent upon circuit conditions flash-arcs may occur without being followed by power-arcs.

#### EFFORTS TO ELIMINATE FLASH-ARCS

Experimental work in connection with the "flash-arc" has been of great value in furnishing directives for its complete elimination, or at least for the minimization of its occurrence.

In theory, at the extremely high vacuum (of the order of .0001 micron Hg pressure) to which modern transmitting tubes are evacuated, interelectrode conduction across the evacuated space may be established by the mechanism of auto-electronic, secondary, or photoelectric emission due to soft X-rays, in addition to the normal cathode plate conduction due to the thermionic emission.

The flash-arc apparently cannot be correlated with the existence of interelectrode currents owing to the secondary electrons, since such arcing takes place independently of the presence of secondary emission.

Auto-electronic emission is the emission or drawing of electrons from the surface of a body by a voltage gradient sufficiently great to overcome the extremely high attractive forces binding them.

Such emission from metals occurs only at extremely high voltage gradients, above those encountered at operating voltages in a vacuum tube of normal design. These currents are very much smaller than the observed flash-arc currents. It has been shown experimentally by Gossling<sup>1</sup> that with a steady auto-electronic emission current of several microamperes flowing between sharp points from anode to cathode of an operating vacuum tube, no increased tendency to produce a flash-arc or power arc in the interelectrode space was noted.

Photoelectric emission from the electrode structure of the tube may occur also under the influence of X-rays from the anode. Soft X-rays are emitted by the copper anode under bombardment by the high velocity electrons present during normal operation of high voltage water cooled tubes. The emission thus obtained is again of the order of a few microamperes and hence could not directly account for the spontaneous high conductivity noted during flash-arcing. As in the case of auto-electronic emission, no definite correlation between such X-ray emission currents and flash-arc occurrence has as yet been proved. The random occurrence of the flash-arc points to discontinuous phenomena as its cause rather than to a steady exciting source such as auto-electronic or photoelectric currents.

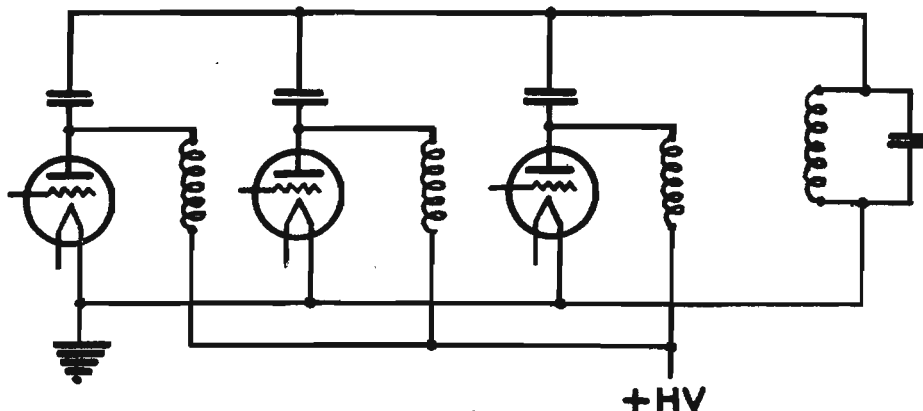

Fig. 1

Illustration of Multiple Parallel Feed of Multiple Tube Amplifier

The flash-arc does not appear to be related to the ordinary gas flash due to cumulative ionization of free gas within the tube. Experimental "softening" of an otherwise "hard" tube by the evolution of a small quantity of free gas within it does not appear to produce increased flash-arcing.

Although experimental confirmation is lacking, it is considered altogether probable that the flash-arc may be initiated by a spontaneous source of positive ions within the tube, such as for instance, a small piloting arc. Such metallic or gas arcs may occur as a result of intermittent contacts between charged electrodes or floating structural elements.

Surface films in poor electrical and thermal contact with the tube structure and hence easily vaporized are also a potential source of such arcs. The resultant sudden space charge neutralization following the liberated positive ions may be of sufficient magnitude to initiate a destructive power-arc.

The experimental evidence so far obtained appears to substantiate the above speculation as to the nature of flash-arcs. Nevertheless, the important feature from the practical operating standpoint is that a rather definite minimum total energy is required to convert such an incipient arc into a dangerous low voltage power arc.

It was found by Gossling<sup>1</sup> that an initial energy of approximately 3 watt-seconds was required to produce complete breakdown of an experimental tube while 0.2 watt-seconds produced only a highly damped input charge with no flash-arc. This very important observation suggests that the energy immediately available at the anode of a high voltage vacuum tube should be kept at the absolute minimum for flash-arc-free operation of a circuit.

Such a highly damped minimum power input, requisite for the discharge, appears to strengthen the theory that an initiating ionization mechanism takes place in a minute pilot arc.

## PROTECTION AGAINST FLASH-ARCS

While new types of the larger water cooled transmitting tubes having relatively wide interelectrode spacings give greater freedom from flash-arcs, experiments indicate this improvement to be slight for small increases of spacing. Hence flash-arc characteristics of the lower output water cooled tubes and means of improving them remain an engrossing problem.

It is conceded that the most important factor in the reduction of flash-arcs in existing transmitting tubes lies in the improvement and refinement of tube production processes themselves. Care in the selection and processing of material for the various parts cannot be relaxed. Incoming materials must be free from checks, blisters, surface scale, inclusions of oxide and foreign material, and of the required degree of purity. Thorough cleaning of all parts is necessarily followed by a carefully designed exhaust schedule. Following exhaust treatment, rigorous high voltage seasoning of the tube is carried out at voltages and currents in excess of those to be encountered in operation in the field.

Simultaneous or nearly simultaneous application of high peak radio frequency plate voltage and current appears to be favorable to the occurrence of flash-arcs. Accordingly, during seasoning, tubes are given high power radio frequency oscillation until flash-arcing ceases.

While high quality tubes are naturally essential to flash-arc-free transmitter operation, this is by no means the sole

solution. Such operation can be obtained only in a properly designed circuit.

The above mentioned requirement that the immediately available charge at the tube anode be held to a minimum provides several directives in transmitter circuit design.

First, the stored energy of the plate blocking condensers should be made as small as possible. In the case of single ended amplifiers or simple push-pull amplifiers the smallest blocking condenser consistent with other design requirements will normally be used for economic reasons. In the case of several tubes in parallel where, because of the low output impedance a rather large plate blocking capacity is required, isolation by provision of a separate condenser and radio frequency choke coil for each tube is recommended (see Fig. 1).

In general, the direct parallel connection of a large number of tubes is conducive to the development of flash-arcing since the combined shunt capacity charge of all the tubes tends to convert what would otherwise be a self-extinguishing damped discharge in one of the tubes into a power arc. Push-pull type circuits are for these reasons to be preferred to parallel or even single ended type amplifiers for a given required power output.

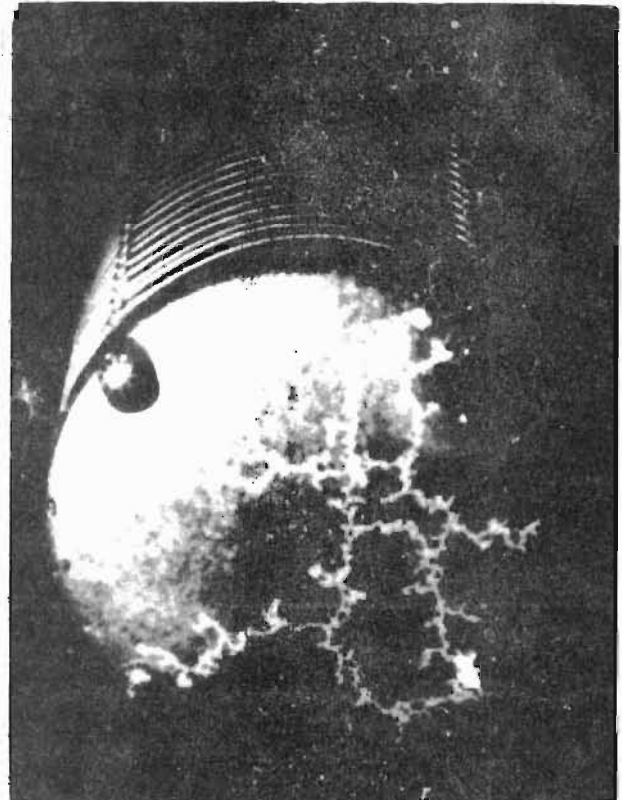

Fig. 2  
*Characteristic flash-arc markings on grid cap of high power water-cooled vacuum tube.*

A second desirable circuit requirement is that the radio frequency choke coil be large. The greater the choke coil inductance the higher the series impedance delaying discharge of the plate circuit power source through the tube in case of an incipient flash-arc. In the case of high frequency telephone and telegraph transmitters where the series inductance between power supply filter condenser and tube in either the parallel or series fed type of circuits

may be inappreciable, the conditions are particularly favorable for the creation of a power arc. In this case it is advisable to insert either series inductance or resistance, depending upon the operational limitations, between filter condenser and tube. In the case of large water cooled tubes operating in a single-ended or two tube push-pull circuit where the available energy of the plate blocking condensers is large and cannot be reduced, the regulatory effect of inductance or resistance in series with the power supply plus rapid relay and circuit breaker operation must be relied upon to limit the power-arc surge current to a safe value.

## PRECAUTIONS IN WATER-COOLING

The importance of a proper water-cooling system cannot be overestimated. It has a direct bearing upon the satisfactory operation and life of water cooled tubes.

Improper cooling is an all too frequent cause of failure of transmitting tubes. The result is increased cost of operation and costly program interruptions. First and foremost in importance, therefore, is a water cooling sys-

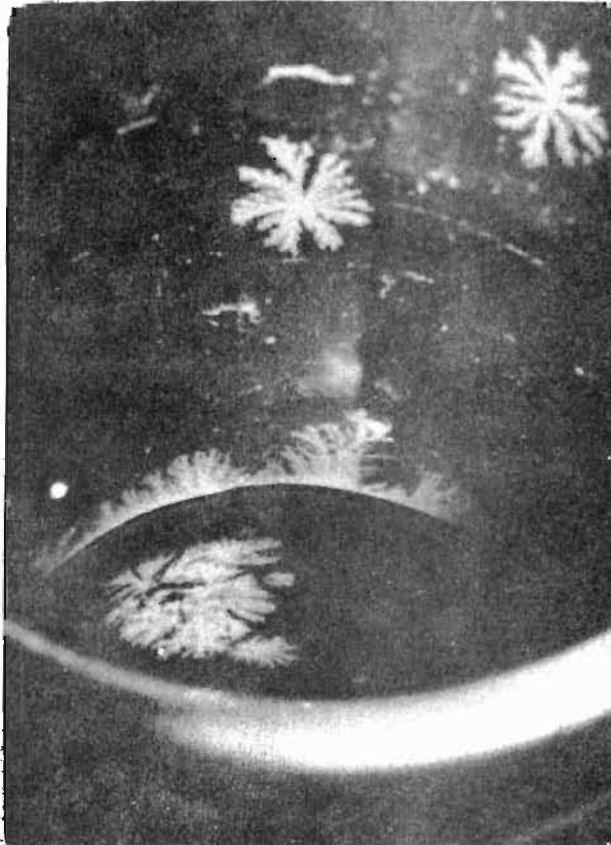

Fig. 3

Characteristic flash-arc markings on inside of anode and anode seal shield of high power water-cooled vacuum tube.

tem conservatively designed to embrace all essential features.

In the satisfactory water-cooling of a vacuum tube it is necessary to take into consideration volume and velocity of flow as well as the electrical and chemical characteristics and temperature of the cooling water.

Formation of a layer of mineral deposit on anodes of tubes must be prevented if difficulty is to be avoided. The heat conductivity of scale of this kind is very poor and severely reduces the anode dissipation capacity.

While regular removal of such deposits by a cleaning routine is necessary when high mineral content cooling water must be used, frequent removal of tubes from the sockets is liable to result in breakage. For this reason it is advisable in such cases to use distilled water in a closed recirculating cooling system. Precautions should be taken, of course, to prevent the rise in mineral content of the water in such a system due to corrosion, electrolysis or solution.

Water softeners and filters may be used to obtain the required degree of softness. Mineral content should be kept less than 15 parts per 100,000 by weight.

Removal of a soft deposit may be effected by careful use of a stiff bristle brush. Hard scale should be removed by dipping anode in a 10 per cent solution of hydrochloric acid, being careful that no acid comes in contact with tube seals. Anodes should be rinsed thoroughly to remove excess acid after cleaning.

Materials used in cooling systems should be resistant to corrosion and electrolytic action. Metals which are low in the electromotive force series, such as copper and its alloys, are for this reason usually considered suitable for this purpose. Guard electrodes should be provided to protect against deterioration of installation fittings by electrolysis.

Water conductivity should be kept to a low value to reduce anode leakage current through the hose or ceramic insulating reels or piping. Thus water resistivity should not be less than 4000 ohms per inch cube.

It is essential that adequate surface velocity as well as rate of flow of anode cooling water be maintained always. Maintenance of the recommended rate of flow in a properly designed jacket for a particular type of tube provides the required surface velocity for safe operation at the maximum rated anode dissipation.

Too low a flow or an improper jacket will cause boiling and local heating with danger of anode puncture or release of gas in tube. It should also be noted that while intake and outlet water temperatures may be well within specified limits, boiling and local heating with consequent danger to tube may exist.

### References:

- (1) *The Flash-Arc in High Power Valves* by E. S. Gossling—*I. E. E. Wireless Section Proceedings*. Vol. 7, No. 21, Sept., 1932, pp. 192-219.
- (2) *High-Power Valves* by J. Bell, J. Davies, and B. S. Gossling—*I. E. E. Wireless Section Proceedings*. Vol. 13, No. 39, Sept., 1938, pp. 194-195.

# GRAPHICAL METHODS OF HARMONIC ANALYSIS

## INTRODUCTION

FOR high quality application of transmitting tubes, the harmonic distortion must be kept within specified limits and preferably at a minimum. It follows that a precalculation of harmonic distortion produced by the transmitting tube in the stage in question must be made. Repeated calculations will have to be made until the harmonic distortion is within the specified limits. It becomes necessary therefore to have methods available that will allow for calculation with the least effort and in the shortest possible time.

### METHODS OF WAVE ANALYSIS

The ultimate solution of the problem of analyzing a given wave into its harmonics would be purely mechanical, or electromechanical. One would need merely follow the outline of the wave with a stylus of a calculating machine, and as a result, read on the machine the amplitudes of the various harmonics. Unfortunately, however, there are few such machines in existence and these are not within reach of the station engineer.

Fundamentally, any accurate analytical computation of amplitudes of harmonics must be based on the Fourier series. When a curve to be analyzed is a regular function, the actual integrations can be performed by one of the methods given in the integral calculus. However, the numerical determination of the coefficients in a Fourier series by successive integration is tedious and takes much time.

Considerable ingenuity has been displayed in devising various purely graphical ways of evaluating the coefficients in a Fourier series. Projection on a cylinder has been employed; special coordinate paper has been used; ordinates have been measured with special scales for each harmonic, and charts have been constructed.

Two simplified methods will be described and examples of calculations illustrated. These methods are similar in that the harmonics are determined by measuring ordinate differences from a straight line joining the extremes of the modulation curves.

#### Method I

Applicable to Class B A-F, Class AB, and Class A push-pull, A-F amplifiers.

#### Method II

Applicable to Class A A-F, Class B R-F, and Class C, plate modulated amplifiers.

### METHOD I<sup>1</sup>

Since this method deals with amplifiers working always in push-pull, only sine components of odd harmonics are possible. From the symmetry of the modulation curve, it can be seen that all cosine components of even harmonics are excluded.

The modulation characteristics of a single tube of a Class B audio frequency amplifier as obtain from the

plate characteristic curves, of the tube illustrated, is shown as OCA in Fig. 1. The assumption is made that the input voltage is a sine wave. Taking the ordinates of grid voltage as a function of the sine of time angle of the fundamental frequency, it can be shown that for no distortion the modulation characteristic must be a straight line. If graphs of all the odd harmonics up to the eleventh are plotted and compared with the modulation curve, points yielding the simplest equations are found.

Taking the total grid voltage swing as  $e_0 = 1 = x$ , these points correspond to values of  $x = 0.309$ ;  $0.5$ ;  $0.707$ ;  $0.809$ , and  $0.866$ , which are the sines of the respective angles of fundamental frequency:  $18^\circ$ ;  $30^\circ$ ;  $54^\circ$  and  $60^\circ$ .

These equations are as follows:

$$I_{05} = 0.4 (a - d)$$

$$I_{03} = 0.4475 (a + d) + b/3 - 0.578f - 0.5 I_{05}$$

$$I_{07} = 0.4475 (a + d) - I_{03} + 0.5 I_{05}$$

$$I_{09} = I_{03} - 2/3 b$$

$$I_{011} = 0.707c - I_{03} + I_{05}$$

where (a) in Fig. 1, is the ordinate difference between the straight line OA and the modulation curve OCA at the value of  $x = 0.309$ ; (b) at  $x = 0.5$ ; etc. Ordinate differences lying below the chord are positive and those above the chord are negative.

The true amplitude of the fundamental frequency is given as:

$$I_{01} = I_a - I_{03} + I_{05} - I_{07} + I_{09} - I_{011}$$

The ratio of the harmonic amplitudes to the fundamental gives their respective percentage of distortion.

As an illustration, take the modulation curve OCA in Fig. 1. In this particular case of a Class B audio frequency amplifier, the plate voltage is  $E_p = 2000$  volts and the load resistance,  $R_L = 3460$  ohms.

Let the grid swing from  $-130$  to  $+88$  volts, the total grid excitation being  $218$  volts, and call this value  $e_0$ .

Connect the ends of the curve by the straight line OA. Measure the ordinate differences for the values of grid excitation amounting to  $0.309$ ;  $0.5$ ;  $0.707$ ;  $0.809$ ;  $0.866$  of its amplitude  $e_0$ . Calculations are made independent of the current and voltage scales by measuring the ordinate differences as divisions of the cross-section paper.



The ordinate differences are in this case:  
 $a = 0; b = -3; c = -3.5; d = -3.5; f = -3$   
 by applying the equations for  $I_{05}; I_{03};$  etc., we find:

$I_{03} = -4.99$	3.68%	distortion
$I_{05} = 1.4$	1.03	"
$I_{07} = -4.13$	3.05	"
$I_{09} = -2.99$	2.20	"
$I_{11} = 3.91$	2.89	"
Total	12.85%	"

and the true amplitude of fundamental frequency is  
 $I_{01} = 140 + 4.99 + 1.4 - 4.13 - 2.99 - 3.91 = 135.4$

The value of distortion found under this condition is excessive. Further calculation at a different value of load resistance would be necessary to find a condition of operation that would be suitable.

### METHOD II<sup>2</sup>

It can be shown that a periodic wave resulting from a dynamic characteristic such as OCA in Fig. 2, possesses only sine component terms of odd harmonics and cosine component terms of even harmonics. This will hold true

Class B radio frequency amplifier as obtained from the plate characteristic curves of the tube is shown as OCA in Fig. 2. In a manner similar to Method I, it can be proven that for no distortion the modulation characteristic must be a straight line. If graphs of all the harmonics, up to the seventh, are plotted and compared with the modulation curve, points producing the simplest equations are found.

Taking one-half of the total grid voltage swing as  $e_g = 1 = x$  about the operating point C, in this case, the carrier point, these points correspond to values of  $x = -0.707; -0.5; 0; 0.3; 0.5; 0.707$ .

The equations thus found are as follows:

$$\begin{aligned}
 I_{02} &= 1/3 (d + b) + 1/4 (c - f - a) \\
 I_{03} &= 1/3 (d - b) \\
 I_{04} &= 1/4 (c - f - a) \\
 I_{05} &= 1/3 (d - b) + 0.353 (a - f) \\
 I_{06} &= 0.5 (c) - I_{02} \\
 I_{07} &= 0.873 (g - 1.82 I_{02} - 1.092 I_{03}) \\
 &\quad + 0.873 (0.6552 I_{04} - 0.699 I_{05} - 0.751 I_{06})
 \end{aligned}$$

where (a), Fig. 2, is the ordinate difference between the straight line OB and the audio envelope curve OPB at the value of  $x = -0.707$ ; (b) at  $x = -0.5$ ; etc. Ordinate distances measured upward from the chord are called positive; those measured downward as negative.

The true amplitude of the fundamental frequency is given as:

$$I_{01} = 0.5 I_a + I_{03} - I_{05} + I_{07}$$

The ratio of the harmonic amplitudes to the fundamental gives their respective percentage of distortion.

As an illustration, let us take the plate current curve OCA in Fig. 2. In this particular case of a Class B radio frequency amplifier, the plate voltage is  $E_p = 12,000$  volts and the load resistance,  $R_L = 5,400$  ohms.

Let the grid swing from  $-300$  to  $+700$  volts, the total grid excitation being  $1,000$  volts. Take half of this value as  $e_g$ . Before being able to measure ordinate difference, it is necessary to plot the A-C value of the modulated current. This is done by computing the power output for the values of (grid voltage)  $x = -0.707; -0.5; 0; 0.3; 0.5; 0.707$ ; and finding the A-C value of the modulated current by taking the square root of twice the power output divided by the load resistance. This gives the audio envelope curve OPB. Connect the ends of the curve by the straight line OB and measure the values or ordinate differences at the values of  $x$  given above. Calculations can be made independent of the current and voltage scales by measuring the ordinate differences as divisions of the cross-section paper.

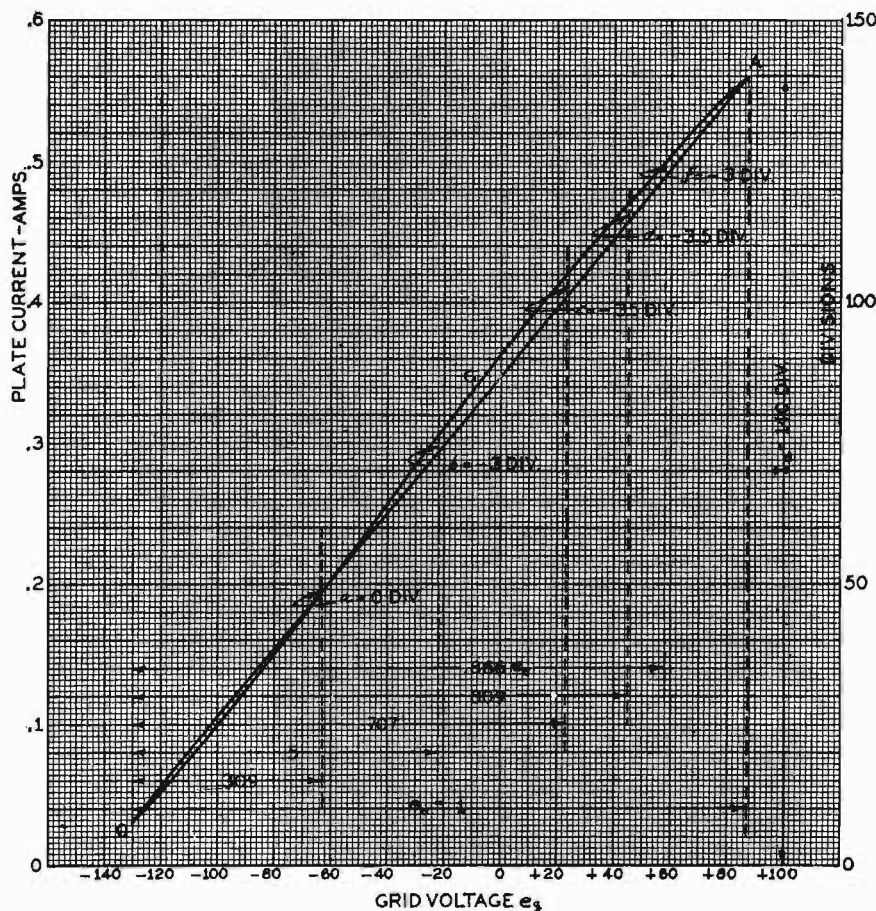

Fig. 1

for Class A amplifier operating into a pure resistance load, a Class B radio frequency amplifier, and a Class C plate modulated radio frequency amplifier.

The modulation characteristics of a single tube of a

# HANDBOOK OF TUBE OPERATION

The ordinate differences are in this case:

$$a = -3; b = -4; c = -3; d = 0; f = 1; g = -1$$

by applying the equations for  $I_{02}$ ;  $I_{03}$ ; etc., we find

$I_{02} = -1.58$	3.23% distortion
$I_{03} = 1.33$	"
$I_{04} = -0.25$	"
$I_{05} = 0.07$	"
$I_{06} = 0.08$	"
$I_{07} = 0.14$	"

Total 7.14%

and the true amplitude of fundamental frequency is:

$$I_{01} = 0.5 \times 95 + 1.33 - .07 + .14 = 48.9.$$

Further calculation at a different value of load resistance would be necessary to find a condition of operation that would give less distortion.

## SUMMARY

The above methods allow for rapid calculation of distortion of modulation curves and in general will give results sufficiently accurate for all design purposes. If desired, the calculations can be extended to include harmonics of higher order and allow for greater accuracy but this will at the same time complicate the equations and increase the labor involved.

### References:

1. I. E. Mouromtseff and H. N. Kozanowski, "A Short Cut Method for Calculation of Harmonic Distortion in Wave Modulation," *Proc. I. R. E.* 22, 1090 (1934).
2. J. A. Hutchison, "Graphical Harmonic Analysis," *Electronics*, January, p. 16 (1936).

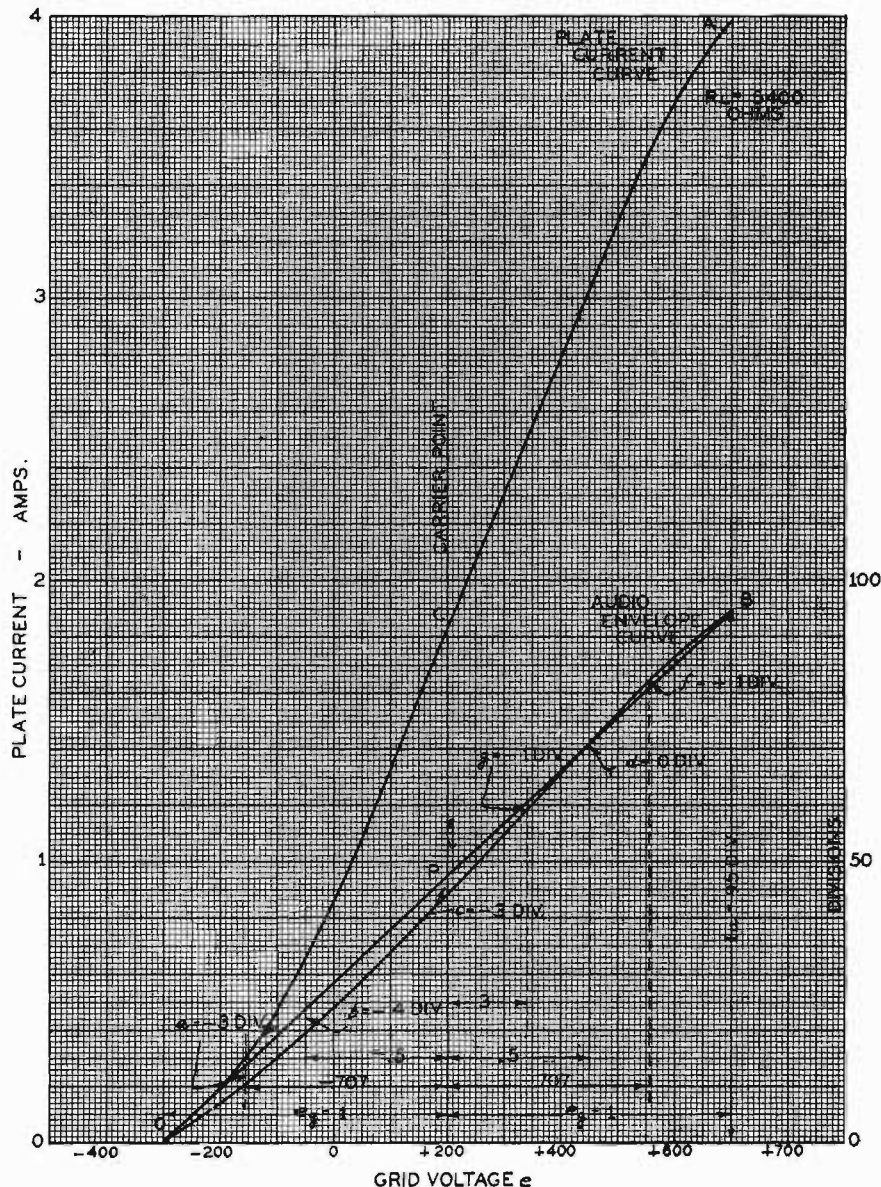

Fig. 2

# CALCULATION OF CLASS C PLATE MODULATED RF POWER AMPLIFIERS

## INTRODUCTION

THE ever-growing need of final amplifiers operating at higher efficiencies makes it helpful for the transmitter engineer to have tools to explore the problems of Class C plate modulated radio frequency amplifiers. It is the purpose of this chapter, therefore, to illustrate and discuss one method of calculation using constant current curves.

### GENERAL THEORY

If not obtainable, constant current curves can be constructed by reploting the plate and grid characteristic curve of the tube to be used in the final amplifier. These curves will show the relationship between grid voltage and plate voltage with constant plate current or with constant grid current. The chart shown in Fig. 1 is for a Federal type F-320-B tube.

Since both the grid and plate potentials are considered to vary as sine waves, every dynamic characteristic for Class C operation is a straight line. Let the straight line AB in Fig. 1 represent the dynamic characteristic for carrier condition. From this straight line the plate-current time curve may be plotted as shown in Fig. 2. In order to obtain the average or direct plate current the plate-current time curve averaged over the complete cycle must be taken.

This is established by dividing the area of the current time curve into nine strips, each ten electrical degrees wide, and then measuring the middle ordinates of each

strip, summing up the middle ordinates and dividing the sum by eighteen. The whole procedure can be greatly simplified by the use of a sine scale as shown in Fig. 3.

This scale consists of a piece of celluloid, one edge being the base of an isosceles triangle. The base is marked off in sines of the angles of the middle ordinates; that is,  $5^\circ$ ,  $15^\circ$ ,  $25^\circ$ ,  $35^\circ$ ,  $45^\circ$ ,  $55^\circ$ ,  $65^\circ$ ,  $75^\circ$ , and  $85^\circ$ , the base being the sine of  $90^\circ$  or equal to unity. Thus by laying the sine scale on the dynamic characteristic so that the sides of the triangle coincide with the ends of the dynamic characteristic and the base parallel to it, the values of the instantaneous plate current in the middle of each strip can be read and the plate time curve plotted from the same readings.

By multiplying the instantaneous values of plate current by the sines of their respective angles, summing up the products and dividing by eighteen, the radio-frequency current is found. Multiplication of this value by the plate voltage swing gives the power output. The effective load impedance is then equal to the plate voltage swing squared, divided by twice the power output.

### CARRIER CONDITION

As an illustration, assume that it is required to obtain a carrier power output of 5 kilowatts from a Federal type F-320-B tube operating at a plate voltage,  $E_b = 9,000$  volts. By drawing several dynamic characteristic lines and computing the power output, the carrier line AB as shown on Fig. 1 is finally determined. This line satisfies the condition of 5 kilowatts power output at the plate voltage,  $E_b = 9,000$  volts.

For this condition of operation the grid bias is  $E_c = -840$  volts. The maximum positive grid potential is  $e_{c \max} = +660$  volts. The total grid voltage swing is then  $E_g = -E_c + e_{c \max} = 1500$  volts. The minimum value of plate voltage,  $e_{b \min} = 1500$  volts, and the plate voltage amplitude,  $E_p = E_b - e_{b \min} = 7,500$  volts. The plate-current time curve is shown in Fig. 2. The average or direct plate current is  $I_b = 0.757$  amperes and the plate input power,  $P. I. = 6.8$  kilowatts.

The radio-frequency current is found to be,  $I_p = 0.68$  amperes. The product of this value and the plate voltage amplitude,  $E_p = 7,500$  volts, yields the value of power output,  $P. O. = 5.1$  kilowatts. The efficiency equals the power output divided by the power input,  $n = 75$  per cent. The effective load impedance,  $R_L = E_p^2 / 2 P. O. = 5500$  ohms.

The same procedure is followed with the grid-current time curve which is shown in Fig. 2. The average or direct grid current is  $I_g = 0.041$  amperes. The product of this

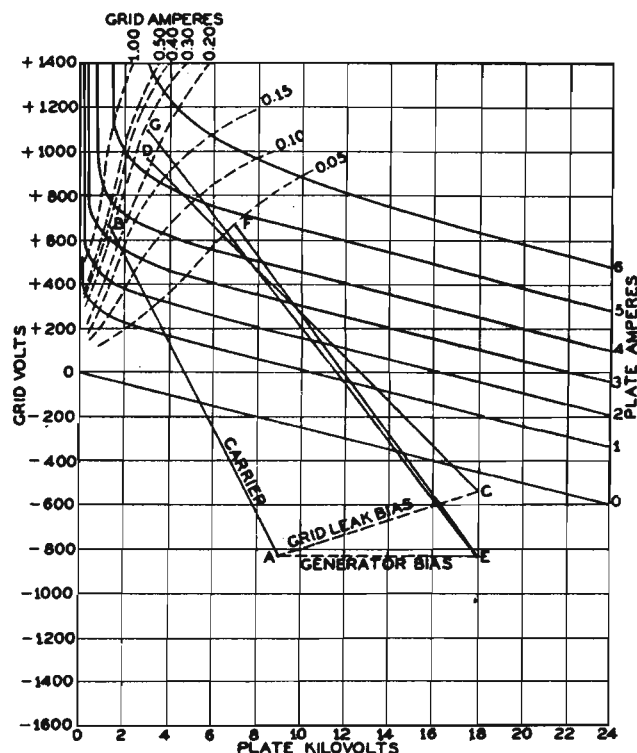

Fig. 1.

Constant Current Chart. Federal Type F-320-B Vacuum Tube.

# HANDBOOK OF TUBE OPERATION

value and the total grid voltage swing,  $E_g = 1500$  volts, yields the grid driving power,  $P_g = 61$  watts. The bias loss is the product of the bias volts,  $E_c = -840$ , and the average grid current,  $I_g = 0.041$ , and is equal to 34 watts. The calculation for both the plate and grid is tabulated under Fig. 2.

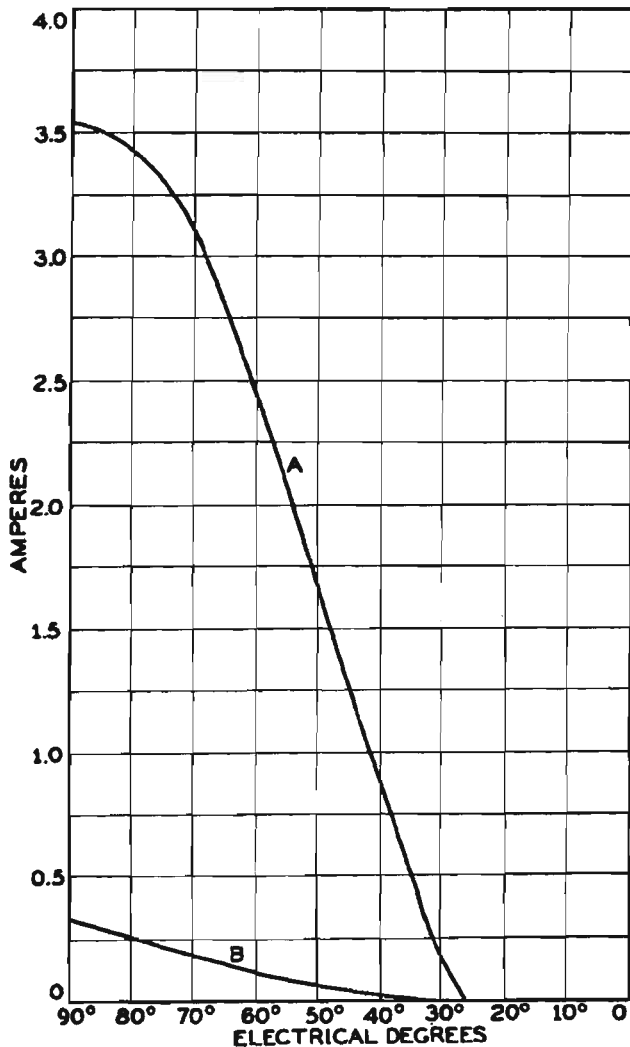

Fig. 2.  
Current-Time Curves. A—Plate. B—Grid.

## PLATE VALUES OF MID-ORDINATES

3.5 amperes	$\times 0.996$	which is	$\sin 85^\circ = 3.49$
3.3	$0.966$	$\sin 75^\circ = 3.18$	
2.8	$0.906$	$\sin 65^\circ = 2.54$	
2.2	$0.819$	$\sin 55^\circ = 1.80$	
1.3	$0.707$	$\sin 45^\circ = 0.92$	
0.5	$0.573$	$\sin 35^\circ = 0.29$	

$$\frac{13.6}{18} = 0.757 = I_p, \quad I_p = \frac{12.2}{18} = 0.68$$

P. O. =  $0.68 \times 7.5$  kilovolts = 5.1 kilowatts  
 P. I. =  $0.757 \times 9.0$  kilovolts = 6.8 kilowatts  
 $n = 75$  per cent  
 $R_L = 7500/2 \times 5100 = 5500$  ohms

## GRID VALUES OF MID-ORDINATES

0.29  
 0.21  
 0.13  
 0.08  
 0.03

$$\frac{0.74}{18} = 0.041 = I_g$$

$P_g = 0.041 \times 1500 = 61$  watts  
 $P_c = 0.041 \times 840 = 34$  watts

## CREST CONDITION

In an ideal Class C amplifier with 100 per cent modulation, the plate voltage swings at audio frequency down to zero and up to twice the carrier plate voltage, requiring the maximum power output to be exactly four times the carrier power for distortionless operation. At the same time, this power must be delivered into the load resistance fixed by the carrier condition. It is therefore evident that the dynamic characteristic at 100 per cent modulation must fulfill the requirements of four times the carrier power output and the same value of load resistance.

## BIAS SUPPLIED BY A GRID-LEAK RESISTANCE

If a grid-leak is used, the value of the resistance must be such as to satisfy the carrier condition. The value of the grid-leak must be equal to the grid bias voltage,  $E_c = -840$  divided by the average grid current,  $I_g = 0.041$  amperes and is equal to  $R_g = 20,500$  ohms. The grid excitation is the same as the carrier condition,  $E_g = 1500$  volts.

After a series of computations at a plate voltage,  $E_b = 18,000$  volts, and different values of bias, it is found that the operating point will be at C and the dynamic characteristic line CD. Now the point C fixes the grid bias as  $E_c = -540$  volts and this value must be realized from the average grid current calculated along the dynamic characteristic line CD, multiplied by the value of the grid leak  $R_g = 20,500$  ohms. The power output in this case is exactly four times the carrier output, =  $4 \times 5.1 = 20.4$  kilowatts.

The tabulated results of the calculations for the line CD are as follows:

Average plate current,	$I_b$	1.70	amperes
Power Output,	P.O.	20.4	kilowatts
Power Input,	P. I.	30.5	kilowatts
Plate dissipation,	$P_h$	10.1	kilowatts
Efficiency,	$n$	67	percent
Average grid current,	$I_g$	26	milliamperes
Grid bias,	$E_c$	-540	volts
Grid driving power,	$P_g$	39	watts
Grid bias dissipation,	$P_c$	14	watts
Load resistance,	$R_L$	5500	ohms

This dynamic characteristic line fulfills all of the conditions of equilibrium and should give stable operation. It should be noted that the efficiency has dropped off from the carrier value of 75 per cent to 67 per cent and the downward change in bias has shifted the operation from Class C to almost Class B.

## OPERATION WITH FIXED BIAS

With the bias supplied by a generator, a series of calculations at a plate voltage,  $E_b = 18,000$  volts, and different values of plate voltage amplitude, yields the line EF as the only dynamic characteristic which satisfies the load resistance established by the carrier condition.

The tabulated results of the computations for the line EF are as follows:

Average plate current,	$I_b$	1.17	amperes
Power Output,	P.O.	11.1	kilowatts
Power Input,	P. I.	21	kilowatts
Plate dissipation,	$P_h$	10.1	kilowatts
Efficiency,	$n$	53	per cent
Average grid current,	$I_g$	5	milliamperes
Grid bias,	$E_c$	-840	volts
Grid driving power,	$P_g$	7.5	watts
Grid bias dissipation,	$P_c$	4.2	watts
Load resistance,	$R_L$	5500	ohms

Even though the bias has not shifted and the type of operation is Class C, the efficiency has dropped from a carrier value of 75 per cent to 53 per cent. The power output is only 11.1 kilowatts instead of the required value of 20.4 kilowatts for no distortion. Thus it can be seen that for the carrier condition assumed, there is no stable condition of operation when the bias is fixed. In the above case as well as in the case for grid-leak bias, the grid excitation voltage has been considered to be constant and equal to the carrier condition value.

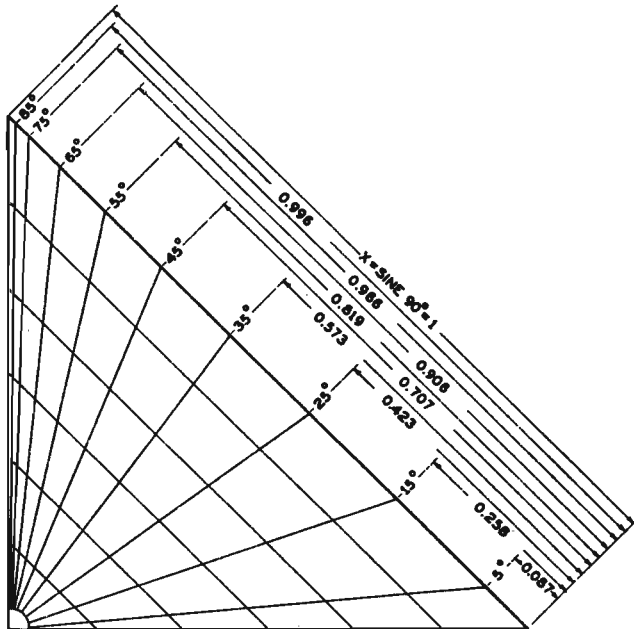

Fig. 3.  
Sine Scale.

## COMPENSATION

Operation of Class C amplifiers with grid excitation voltage changing with each audio cycle is one method of

compensation. This can be accomplished by partly modulating the plates of the exciter stage from a tap or small transformer connected to the main modulating transformer, or by varying the bias of the exciter stage. Compensation may be applied to grid-leak bias as well as to fixed bias operation. In the case here shown the fixed bias condition has been chosen for illustration.

Taking the results obtained for the fixed bias operation, it is evident that an increase in excitation voltage is necessary to obtain the power output value of 20.4 kilowatts. The bias is still fixed at the value,  $E_c = -840$  volts. A series of calculations were made with different values of grid excitation voltage until the dynamic characteristic line EG was obtained, which satisfies both conditions of equilibrium; that is, four times carrier power output into the carrier load resistance. The tabulated results for the compensated condition are as follows:

Average plate current,	$I_b$	1.63	amperes
Power Output,	P.O.	20.4	kilowatts
Power Input,	P. I.	29.2	kilowatts
Efficiency,	$n$	70	per cent
Average grid current,	$I_g$	40	milliamperes
Grid bias,	$E_c$	-840	volts
Grid driving power,	$P_g$	78	watts
Grid bias dissipation,	$P_c$	33	watts
Load resistance,	$R_L$	5500	ohms

The grid excitation voltage value  $E_g$  has been increased from the value of 1500 to 1940 volts. This increased value can be obtained by modulating the exciter stage by 29 per cent. The efficiency, though lower than at carrier, has increased from the fixed bias condition of 53 per cent to the present value of 70 per cent.

## SUMMARY

Although not shown in the example illustrated, grid-leak bias generally gives power outputs, for crest conditions, in excess of the four times the carrier value and produces distortion from that cause. With a fixed bias, it is practically impossible to obtain satisfactory operation due to the distortion caused by the deficiency of power output at the crest condition.

A combination of both grid-leak and fixed bias will counterbalance the faults of both methods and give a lower value of distortion than with either method alone. With compensation applied to either the grid-leak or the fixed bias method, the distortion in the Class C amplifier itself can be eliminated or reduced to a very low value.

. . . . .

## BIBLIOGRAPHY

1. E. Mouromtseff and H. N. Kozanowski, "An Analysis of the Operation of Vacuum Tubes as Class C Amplifiers," *Proc. I. R. E.*, 23, 752 (1935)
2. E. L. Chaffee, "The Operating Characteristics of Power Tubes," *J. App. Phys.*, 9, 471. (1938).

# CALCULATION OF CLASS B RADIO FREQUENCY POWER AMPLIFIERS

## INTRODUCTION

THE general trend of increased power applications without changing the existing transmitter has in many instances resulted in the use of an additional final stage operating as a Class B radio frequency amplifier. It is the purpose of this chapter to illustrate and discuss two methods of calculation and to make an harmonic analysis of the modulation characteristics.

### GENERAL THEORY

If not obtainable, constant current curves can be constructed by replotting the plate and grid characteristic curves of the tube which is to be used in the final amplifier. These curves will show the relationship between grid voltage and plate voltage with constant plate current or with constant grid current. The chart shown in Fig. 1 is for a Federal type F-320-B tube.

Since both the grid and plate potentials are considered to vary as sine waves, every dynamic characteristic for Class B operation is a straight line. Let the straight line AB in Fig. 1 represent the dynamic characteristic for carrier condition. From this straight line, the plate-current time curve may be plotted. In order to obtain the average or direct plate current, the plate-current time curve average over the complete cycle must be taken.

This is established by dividing the area of the current time curve into nine strips, each ten electrical degrees wide, and then measuring the middle ordinates of each strip, summing up the middle ordinates and dividing the

sum by eighteen. The whole procedure can be greatly simplified by the use of a sine scale as explained on page 27.

By multiplying the instantaneous values of plate current by the sines of their respective angles, summing up the products and dividing by eighteen, the radio-frequency current is found. Multiplication of this value by the plate voltage swing gives the power output. The effective load impedance is then equal to the plate voltage swing squared, divided by twice the power output.

### CARRIER CONDITION

As an illustration, assume that it is required to obtain a carrier power output of 2.5 kilowatts from a Federal type F-320-B tube operating at a plate voltage,  $E_b = 12,000$  volts. From the definition of Class B operation, the tube must be biased at or near cut-off value of plate current for the operating plate voltage, so that the plate current cycle will flow over 180 electrical degrees. This fixes the point A (Fig. 1) at grid voltage value of 300 volts or less.

In order to keep distortion to a low value, it is generally advisable to have the tube draw a small amount of current at no signal. The assumed value of plate current in this case was taken at 0.150 amperes resulting in a grid bias  $E_c = -260$  volts and locating point A. By drawing several dynamic characteristic lines, through point A and computing the power output, the carrier line AB as shown on Fig. 1 is finally determined. This line satisfies the condition of 2.64 kilowatts power output at the plate voltage  $E_b = 12,000$  volts.

For this condition of operation the grid bias is already given as  $E_c = -260$  volts. The maximum positive grid potential is  $e_{c \text{ max.}} = +240$  volts. The total grid voltage swing is then  $E_g = -E_c + e_{c \text{ max.}} = 500$  volts. The minimum value of plate voltage,  $e_{b \text{ min.}} = 6,800$  volts, and the plate voltage amplitude,  $E_p = E_b - e_{b \text{ min.}} = 5,200$  volts. The average or direct plate current is  $I_b = 0.640$  amperes and the plate input power, P. I. = 7.68 kilowatts.

The radio-frequency current is found to be  $I_v = 0.508$  amperes. The product of this value and the plate voltage and the plate voltage amplitude,  $E_p = 5,200$  volts, yields the value of power output, P. O. = 2.64 kilowatts. The efficiency equals the power output divided by the power input,  $\eta = 34.4$  per cent. The effective load impedance,  $R_L = E_p^2 / 2 \text{ P.O.} = 5,100$  ohms.

By inspection it can be seen that the grid current values are practically zero and the average value of grid current for carrier conditions will be only a few milliamperes. The grid driving power is taken as zero. No serious

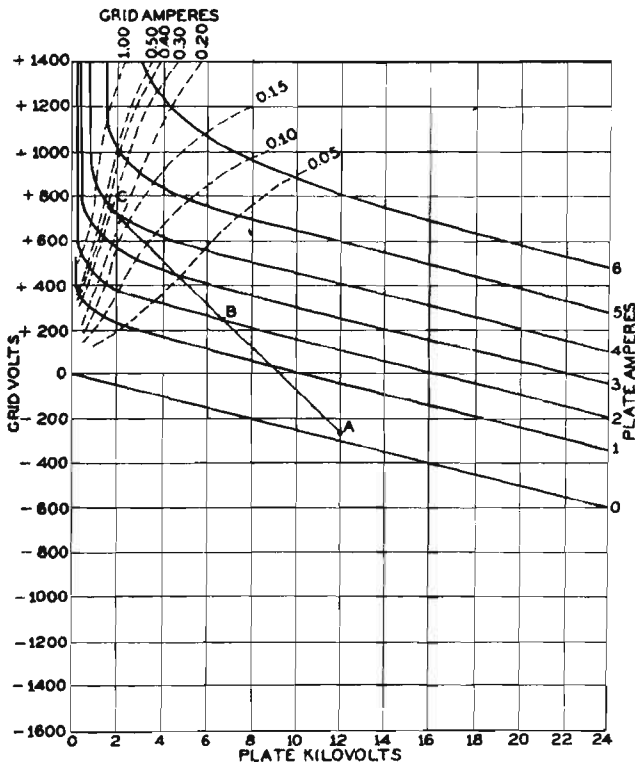

Fig. 1.

Constant Current Chart. Federal Type F-320-B Vacuum Tube.

error is involved since the maximum grid driving power occurs at the crest condition. The plate-current time curve is not illustrated, but the curve is similar to the one shown in Issue No. 10 of TUBES, excepting that

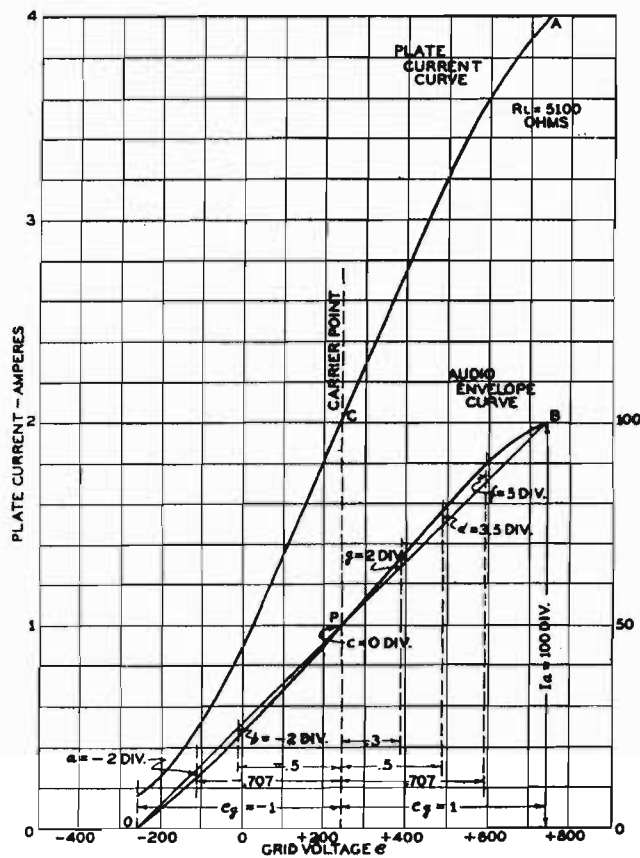

Fig. 2.

the current flows for the full 90 electrical degrees of the half cycle.

The plate values of mid-ordinates and the results of the calculations for the carrier line AB are as follows:

### PLATE VALUES OF MID-ORDINATES

2.10 amperes	x 0.996	which is	$\sin 85^\circ = 2.09$
2.00	0.966		$\sin 75^\circ = 1.93$
1.90	0.906		$\sin 65^\circ = 1.70$
1.75	0.819		$\sin 55^\circ = 1.45$
1.35	0.707		$\sin 45^\circ = 0.93$
1.00	0.573		$\sin 35^\circ = 0.57$
0.75	0.423		$\sin 25^\circ = 0.32$
0.50	0.258		$\sin 15^\circ = 0.12$
0.25	0.087		$\sin 5^\circ = 0.02$
11.50			9.13
$\frac{\quad}{18} = 0.640 = I_b$			$I_p = \frac{\quad}{18} = 0.508$
P.O. = 0.508 x 5.2 kilovolts = 2.64 kilowatts.			
P.I. = 0.640 x 12.0 kilovolts = 7.68 kilowatts.			
n = 34.4 per cent.			
$R_L = 5200^2 / 2 \times 2640 = 5100$ ohms.			

### CREST CONDITION

In an ideal Class B amplifier with 100 per cent modulation the total grid voltage and plate voltage swing are doubled. The output current is also doubled, requiring the maximum power output to be exactly four times the

carrier power for distortionless operation. At the same time, this power must be delivered into the load resistance fixed by the carrier condition. It is, therefore, evident that the dynamic characteristic at 100 per cent modulation must fulfill the requirements of four times the carrier power output and the same value of load resistance.

Since the carrier grid voltage swing must be doubled for the crest condition,  $E_g = 2 \times 500 = 1000$  volts. Now the bias voltage is the same as the carrier condition,  $E_c = -260$  volts. Then  $e_{c \max} = E_g - E_c = 740$  volts. The plate voltage amplitude also is doubled,  $E_p = 2 \times 5,200 = 10,400$  volts. Therefore, the minimum value of plate voltage,  $e_{b \min} = E_b - E_p = 1600$  volts. The values of  $e_{c \max}$  and  $e_{b \min}$  locate the point C. The dynamic characteristic line for the crest condition is then AC as shown in Fig. 1.

A tabulation of the results of the calculations for the line AC is as follows:

Average plate current	$I_b$	1.284	amperes
Power Output	P.O.	10.6	kilowatts
Power Input	P.I.	15.4	kilowatts
Plate dissipation	$P_b$	4.8	kilowatts
Efficiency	n	68.9	per cent
Average grid current	$I_c$	44	milliamperes
Grid bias	$E_c$	-260	volts
Grid driving power	$P_g$	44	watts
Load resistance	$R_L$	5100	ohms

This dynamic characteristic line fulfills all of the conditions of equilibrium and should give stable operation. In the illustration here shown the carrier condition has been calculated first. Actually it is more convenient to assume four times the carrier output and to compute the crest condition. The carrier condition is then checked to see if it agrees with the crest condition. This procedure is repeated until a dynamic characteristic is obtained that satisfies the conditions of equilibrium.

### ALTERNATE METHOD<sup>1</sup>

A simplified method has been published by W. G. Wagener on computing the performance of transmitting tubes. By analysis of actual current pulses obtained in tubes it was found that the plate current pulse followed closely a sine wave and that the grid current pulse approximated a squared sine wave.

Take the carrier conditions the same as previously determined,  $E_b = 12,000$  volts,  $I_b = 0.640$  amperes,  $E_c = -260$  volts and the angle  $\theta$  ninety electrical degrees. At the crest, the tube output and input currents are doubled.

Then at the crest,  $I_b = 1.280$  amperes,  $E_b = 12,000$ ,  $E_c = -260$ , and  $\theta = 90$  degrees. For 90 degrees,  $i_{b \max} / I_b = 3.14$ , and  $I_p / I_b = 1.57$ .

$$i_{b \max} = 3.14 \times 1.280 = 4.02 \text{ amperes.}$$

From the plate characteristic curves of the tube, take the maximum current point at the minimum plate voltage  $e_{b \min} = 1600$  volts. The grid voltage at this point  $e_{c \max} = 740$  volts. From the grid characteristic curves at a plate voltage of 1600 volts and a grid voltage of plus 740 volts, the maximum grid current,  $i_{c \max} = 0.37$  amperes.

$$E_p = 12,000 - 1600 = 10,400 \text{ volts}$$

# HANDBOOK OF TUBE OPERATION

At the carrier,  $I_b = 0.640$  amperes,  $E_b = 12,000$  volts, and  $\theta = 90$  degrees.

$i_{b \max} = 3.14 \times 0.640 = 2.01$  amperes, but the plate swing is one half of the crest value,  
 $E_p = 1/2 \times 10,400 = 5,200$  volts.

Therefore,

$$e_{b \min.} = 12,000 - 5,200 = 6,800 \text{ volts.}$$

From the plate characteristic curves, at  $i_{b \max.} = 2.01$  amperes and  $e_{b \min.} = 6,800$  volts.

$$e_{c \max.} = +240 \text{ volts.}$$

From the grid characteristic curves at a plate voltage of 6,800 volts and a grid voltage of +240 volts, the maximum value of grid current,  $i_{c \max.} = 0.01$  amperes.

The grid bias,  $E_c = -260$  volts is slightly above cut-off at the carrier and  $E_g = 240 + 260 = 500$  volts. At the crest,  $E_g$  must be doubled and, therefore,  $E_g = 2 \times 500 = 1000$  volts.

It has already been shown that for the required plate current at the crest,  $e_{c \max.}$  must be +740 volts. Thus,  $E_c = -(1000 - 740) = -260$  volts, which checks with the value assumed.

A tabulation of the grid circuit calculations follows:

	CARRIER	CREST	
$E_g$	500	1000	volts
$E_c$	-260	-260	volts
$i_{c \max.}$	0.01	0.37	amperes
$\cos \theta_g$	$260/500 = 0.52$	$260/1000 = 0.26$	
$\theta_g$	59	75	degrees
$i_{c \max.}/I_c$	5.8	4.7	
$I_c$	0.0018	0.079	amperes
Driving	$0.9 \times 0.0018 \times 500$	$0.9 \times 0.079 \times 1000$	
Power	= 0.81	= 71	watts
$R_L$	5200	5200	ohms

At the carrier we have finally,

$$I_p = 1.57 \times 0.640 = 1.005 \text{ amperes.}$$

$$P.O. = \frac{1}{2} \times 1.005 \times 5200 = 2.60 \text{ kw.}$$

$$P.I. = 0.640 \times 12,000 = 7.68 \text{ kw.}$$

$$\text{Efficiency} = 33.9 \text{ per cent.}$$

The above results agree closely to those obtained from the calculations using constant current curves. However, it must be realized that the carrier conditions assumed were already determined as being suitable. In the case of this alternate method, conditions of equilibrium are assumed to exist so that for any carrier condition chosen, the crest condition gives four times the carrier power output into the same load impedance. As a check for equilibrium, the bias voltage should not shift between carrier and crest conditions. The grid driving power, in general, is higher for this method as the grid pulse departs from the squared sine wave assumed. In addition no account is taken for secondary emission characteristics of the tube.

## HARMONIC ANALYSIS

The plate current curve for the calculations illustrated is plotted as OCA in Fig. 2. Proceeding as outlined in Method II, Issue No. 9 of TUBES, one half of the total

grid excitation equals 500 volts = x. The values of grid voltage for the points at which the ordinate differences are to be measured are as follows:

$$\begin{aligned} a &= +240 - (0.707 \times 500) = -114 \text{ volts} \\ b &= +240 - (0.5 \times 500) = -10 \\ c &= +240 = +240 \\ g &= +240 + (0.3 \times 500) = +390 \\ d &= +240 + (0.5 \times 500) = +490 \\ f &= +240 + (0.707 \times 500) = +594 \end{aligned}$$

Before being able to measure ordinate differences, it is necessary to plot the A-C value of the modulated current. This is done by computing the power output for the values of grid voltage given in the table above. The A-C value of the modulation current is found by taking the square root of twice the power output divided by the load resistance.

As an example, take the point c which is for the carrier condition. From the previous calculations the modulation current is then  $I_m = (2 \times 2640/5100)^{\frac{1}{2}} = 1.01$  amperes. In like manner the values of modulation current for the other points can be found. The audio envelope curve OPB is then plotted. Connect the ends of the curve by the straight line OB and measure the values of ordinate differences at the values of grid voltage previously given. The ordinate distances are in this case: a = -2; b = -2; c = 0; g = 2; d = 3.5; f = 5. By applying the equations for the harmonics as given in Issue 9 of TUBES we find:

$$\begin{aligned} I_{02} &= -0.375 = 0.71 \% \text{ distortion} \\ I_{03} &= 1.830 = 3.45 \text{ "} \\ I_{04} &= 0.375 = 0.71 \text{ "} \\ I_{05} &= -0.640 = 1.20 \text{ "} \\ I_{06} &= 0.375 = 0.71 \text{ "} \\ I_{07} &= 0.526 = 1.00 \text{ "} \end{aligned}$$

Total 7.78%

and the true amplitude of fundamental frequency is:

$$I_{01} = 0.5 \times 100 + 1.83 + .64 + .53 = 53$$

The value of distortion shown is the arithmetical sum and is not excessive since the geometrical sum is only four per cent.

## SUMMARY

Both methods of calculation agree closely in the case here illustrated. The alternate method does not give a true picture of grid driving power especially for high power water cooled transmitting tubes. In either method several trial calculations must be made before the satisfactory operating condition is found, the alternate method being somewhat faster. In cases of operation where the maximum current and minimum plate voltage point is located in the region of crowding plate characteristics, the alternate method may introduce error. This condition occurs with tungsten filament tubes. In general the alternate method is satisfactory for thoriated tungsten type tubes and calculations in the regions of uniform characteristics.

### References:

1. W. G. Wagener, "Simplified Methods for Computing the Performance of Transmitting Tubes," *Proc. I. R. E.* 25, 47 (1937).



# THE DOHERTY HIGH-EFFICIENCY AMPLIFIER

## INTRODUCTION

GENERAL considerations in the design of the Doherty high-efficiency amplifier must of necessity embrace calculation of tube operating characteristics. It is of interest, therefore, to note how the usual methods of calculation may be applied to tubes when used in the Doherty high-efficiency radio frequency amplifier circuit.

### FUNDAMENTAL PRINCIPLES

References to the Doherty circuit, insofar as concerns the elementary theory and application, are already available<sup>1,2</sup>. Hence, it will serve here simply to review briefly the fundamental principles of operation in order that what follows may be wholly clear particularly as to method of procedure.

The Doherty circuit is a variation of the familiar low-efficiency Class B linear amplifier. Accordingly it requires a previously modulated excitation voltage on its grid. It differs from the aforementioned amplifier fundamentally in that one half of the tube complement supplies practically the entire carrier and negative peak power, while the other half is almost completely cut off up to carrier level. On fully modulated positive peaks each half of the tube complement delivers twice carrier power. Together they deliver the required four times carrier power output required for linear operation.

The output contributions of the two tube sections are so divided as to cause the carrier tubes to operate as in a normal linear R-F amplifier over negative modulation peaks. In other words, RF output voltage varies linearly with grid voltage. On positive peaks, however, the output voltage remains essentially constant at the carrier-level value, while the output current increases to twice carrier amplitude. In this way, twice carrier power is delivered into a load impedance one half that of carrier value. The peak tube complement (with respect to the modulation cycle) delivers simultaneously little or no load on negative modulation half cycles, while on positive peaks it delivers power output increasing from zero at carrier level to twice carrier-level value at 100 per cent modulated crests. Thus it is seen that both carrier and peak tube sections operate under identical AC plate voltage and current conditions at fully modulated crest amplitudes.

### ADVANTAGE OF CIRCUIT

The advantage of Doherty circuit derives from the fact that both carrier and peak tubes operate at rela-

tively high efficiency when compared to the normal Class B linear amplifier. This is due to the higher AC plate voltage amplitudes existing over the greater part of the modulation cycle and to the narrow plate conduction angle of the peak tubes. The theoretical maximum carrier efficiency of the amplifier obtainable with ideal tubes would be 78.5 per cent, the same as the positive crest efficiency for a corresponding ideal low-efficiency linear amplifier. A carrier efficiency of approximately 65 per cent is attained in practice.

The peak tubes are prevented from delivering power on negative modulation peaks by biasing the grids approximately to plate current cutoff at carrier level. It will be noted in Fig. 1, that proper variation of output resistance of both  $V_1$  and  $V_2$  is obtained by means of the properties of a quarter-wave impedance inverting network introduced between the carrier tube plates and the output load resistance  $R_L$ . The ninety electrical degree phase difference between the AC plate voltages of carrier and peak tubes requires a compensating quarter-wave network between the grids to bring respective grid and plate voltages across each tube section into phase. By the use of complementary networks, i. e., one phase advancing and one phase retarding network, and by introducing the excitation voltage directly on the grids of the peak tubes, the required relation of excitation-voltage phase and amplitude between peak and carrier tubes as well as the necessary reduction of positive crest grid excitation voltage on the carrier tube section may be accomplished.

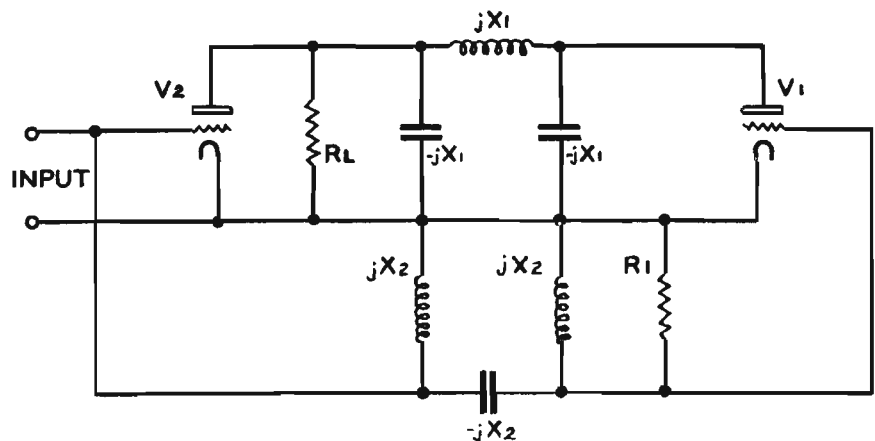

Fig. 1. Simplified Schematic of Doherty Amplifier.

# HANDBOOK OF TUBE OPERATION

This compensating action of the grid network is necessary, since the required rise of carrier tube grid excitation voltage on 100 per cent modulated positive crests is ordinarily only 40 or 50 per cent above the carrier-level value, as compared to 100 per cent in the linear amplifier. The characteristic of the grid network and its termination at the carrier tube grids must be such as to deliver this unsymmetrical voltage for a symmetrical variation of its input voltage, the peak-tube grid excitation, about carrier-level value. In addition, in some cases the required carrier-level excitation voltages of carrier and peak tubes are not the same, the latter requiring a higher positive crest amplitude to compensate for a narrow plate conduction angle and positive-peak saturation effects. The first of these effects may be obtained by partial grid-leak biasing of the carrier tubes or by the reduction of the grid network terminating resistance due to lowered tube grid input resistance on crests. The fixed grid voltage differential between peak and carrier tubes may be obtained by proper relation of grid network constants to the fixed terminating resistance.

While it is apparent that this method of adjustment is computed for linear conditions strictly only at fully modulated crests and over negative modulation peaks, in practice it has been found that the energy balance between peak and carrier tubes is satisfactory over the entire cycle, especially when negative-feedback reduction of distortion is employed.

## MAXIMUM RATINGS

It is apparent that the maximum ratings applicable to the carrier and peak tubes in a Doherty amplifier will be different. Thus the carrier tubes must operate under the same maximum DC plate voltage, DC plate current and R-F grid current as in the low-efficiency linear amplifier. However, since the average power output at 100 per cent modulation is 93 per cent of carrier output, the maximum rated carrier plate dissipation will be 7 per cent greater than in the conventional case. The maximum plate input power for an assumed carrier-tube efficiency of 65 per cent constant over the modulation cycle will be approximately 85 per cent greater than for the low-efficiency amplifier.

The peak tubes, since they deliver very little or no carrier power obviously cannot be rated on the basis of maximum carrier conditions, but must be rated for 100 per cent modulation when they are fully operative. Here maximum ratings for the Class C unmodulated power amplifier apply since its operation conforms essentially to the limits of this class.

In general, it is apparent that the major limiting considerations of the Doherty amplifier are the maximum permissible plate dissipation of the carrier tubes and the maximum attainable peak plate current of the peak tubes. Another limiting factor which becomes apparent in amplifier design is the minimum effective grid resistance

of the carrier tube on modulation crests, i. e., the peak grid current at this point.

For Maximum Frequency of 20 Megacycles	
<b>CLASS B AUDIO AMPLIFIER OR MODULATOR</b>	
D-C Plate Voltage.....	20000 volts
Maximum Signal D-C Plate Current..	5.0 amperes
Maximum Signal Plate Input.....	80000 watts
Plate Dissipation .....	30000 watts
<b>CLASS B R-F POWER AMPLIFIER—TELEPHONY</b>	
(Carrier conditions per tube for use with modulation factor up to 1.0)	
D-C Plate Voltage.....	20000 volts
D-C Plate Current.....	3.5 amperes
R-F Grid Current.....	50 amperes
Plate Input .....	80000 watts
Plate Dissipation .....	40000 watts
<b>CLASS C R-F POWER AMPLIFIER—TELEPHONY—PLATE MODULATED</b>	
(Carrier conditions per tube for use with modulation factor up to 1.0)	
D-C Plate Voltage.....	14000 volts
D-C Plate Current.....	4.5 amperes
D-C Grid Current.....	1.0 amperes
R-F Grid Current.....	50 amperes
Plate Input .....	60000 watts
Plate Dissipation .....	30000 watts
<b>CLASS C R-F POWER AMPLIFIER AND OSCILLATOR—TELEGRAPHY</b>	
(Key-down conditions per tube without modulation)*	
D-C Plate Voltage.....	20000 volts
D-C Grid Voltage.....	—3000 volts
D-C Plate Current.....	7.0 amperes
D-C Grid Current.....	1.0 amperes
R-F Grid Current.....	50 amperes
Plate Input.....	135000 watts
Plate Dissipation .....	40000 watts
* Modulation essentially negative, may be used if the positive peak of the audio frequency envelope does not exceed 115% of the carrier condition value.	

Fig. 2. Maximum Ratings—Federal F-124-A Tube.

The conventional maximum ratings for the Federal F-124-A tube are shown to indicate its adaptability to the Doherty circuit.

## References:

1. W. H. Doherty, "A New High Efficiency Power Amplifier for Modulated Waves," *Proc. I. R. E.*, Vol 24, No. 9, September, 1936.
2. C. E. Strong and G. G. Samson, "An Experimental 5 Kw Doherty Amplifier," *Electrical Communication*, Vol. 16, No. 3, January, 1938.
3. E. L. Chaffee, "The Operating Characteristics of Power Tubes," *J. App. Phys.*, Vol. 9, No. 7, July, 1938.

# MORE ABOUT THE DOHERTY HIGH-EFFICIENCY AMPLIFIER

## PLATE CIRCUIT DESIGN

### Carrier Tube—Crest Condition

Let it be assumed that the required total carrier power output,  $P_o$ , is 52 kilowatts, allowing for 4 per cent circuit losses, or 26 kilowatts per tube. For an overall efficiency,  $N$ , of 65 per cent at supply plate voltage,  $E_b$ , of 17500 DC volts we have for the required peak AC plate voltage amplitude of the carrier tubes,

$$mE_p = 100 \frac{11}{4} (N + 4) E_b = \frac{69}{78.5} 17500$$

$$= 15400 \text{ volts (approximately)}$$

It is necessary to calculate first from the published constant-current characteristics of the Federal F-124-A tube, the operating conditions of  $V_1$  at maximum power output, that is, at 100 per cent modulation crests to determine whether maximum grid drive power and plate dissipation are permissible values. Here it is advantageous to use the rapid and accurate Chaffee<sup>3</sup> method of graphical analysis, although any of the others are applicable. Calculations are carried out as for a Class B R-F amplifier operating at (2 tubes):

$$\begin{aligned} \text{D-C Plate Voltage, } E_b &= 17500 \text{ volts} \\ \text{D-C Grid Bias Voltage, } E_g &= -480 \text{ volts} \\ \text{A-C Plate Voltage, } mE_p &= 15400 \text{ volts} \end{aligned}$$

Since crest power output,  $P_o = 2 \times \text{carrier } P_o = 104$  kilowatts

$$\text{A-C Plate Current, } mI_p = \frac{2 P_o}{mE_p}$$

$$= \frac{2 \times 104}{15400} = 13.5 \text{ amperes}$$

which from constant-current curves is given by

$$mI_p = 2 \times \frac{1}{6} \left[ 14.0 + \sqrt{3} (13.4) + 5 \right]$$

Also,

$$\begin{aligned} \text{D-C Plate Current, } I_b & \\ &= 2 \times \frac{1}{12} \left[ 14.0 + 2 \times 13.4 + 2 \times 5 \right] \\ &= 8.48 \text{ amperes} \end{aligned}$$

$$\begin{aligned} \text{A-C Grid Current, } mI_g & \\ &= 2 \times \frac{1}{6} \left[ 1.8 + \sqrt{3} (-0.1) + (-0.1) \right] \\ &= 0.5 \text{ amperes} \end{aligned}$$

D-C Grid Current,  $I_c$

$$= 2 \times \frac{1}{12} \left[ 1.8 + 2 (-0.1) + 2 (-0.1) \right]$$

$$= 0.23 \text{ amperes}$$

A-C Grid Voltage,  $mE_g$

$$= 790 - (-480 \text{ volts}) = 1270 \text{ volts}$$

from which,

D-C Plate Input Power,  $P_b = 148$  kilowatts

Total Plate Dissipation,  $P_h = 44$  kilowatts

Plate Efficiency,  $N = 70$  per cent

A-C Grid Excitation power,  $P_g$

$$= \frac{0.5 \times 1270}{2}$$

$$= 318 \text{ watts}$$

Minimum Effective Grid Resistance,  $R_g$

$$= \frac{1270}{0.5} = 2540 \text{ ohms}$$

Effective Plate Load Impedance,  $Z_L$

$$= \frac{15400}{13.5}$$

$$= 1140 \text{ ohms}$$

Actual Output Load Resistance,  $R_L$

$$= \frac{1}{2} Z_L$$

$$= 570 \text{ ohms}$$

It may now be seen that crest plate dissipation and drive power are acceptable values, 22 kilowatts and 159 watts per tube respectively.

### Impedance Inverting Network

At this point the network constants are determined.

The properties of quarter-wave networks of interest in this case are expressed as follows:

$$Z_1 = \frac{X^2}{Z_2} \tag{1}$$

$$E_2 = E_1 \frac{Z_2}{X} \tag{2}$$

# HANDBOOK OF TUBE OPERATION

Where  $Z_1$ ,  $E_1$  and  $Z_2$ ,  $E_2$  are input and output impedances and voltages respectively, while  $X$  is the reactance of the network elements.

Since at crest the plate voltage swings and load impedances of  $V_1$  and  $V_2$  are the same, from (2) above we have:

$$X = Z_L = 2 R_L = 1140 \text{ ohms} \quad (3)$$

From (1) it is seen that if  $V_1$  delivers the total carrier power of 52 kilowatts into the actual output resistance

$\frac{1}{2} Z_L$ , through the quarter-wave network it will be operating into an effective plate impedance

$$Z = \frac{(2 R_L)^2}{R_L} = 4 R_L \text{ ohms} \quad (4)$$

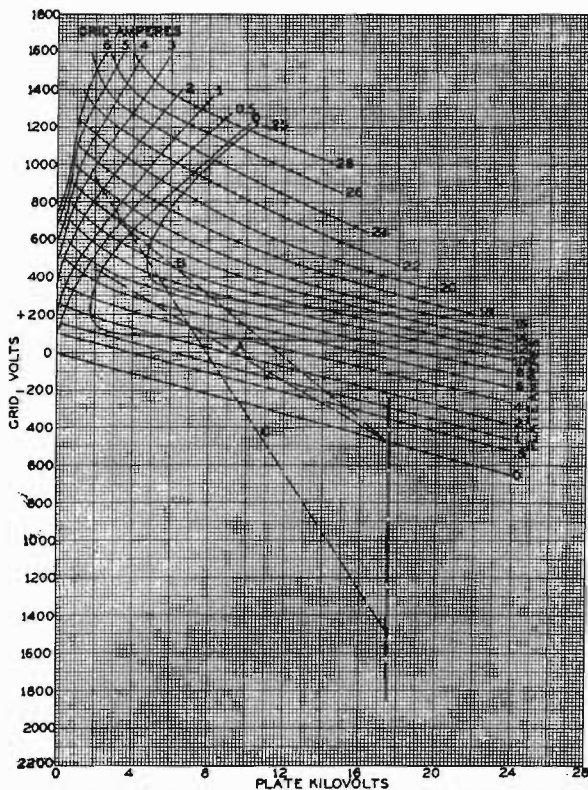

Fig. 1. Current Characteristics of Federal F-124-A Tube with Operating Load Lines.

- A: Carrier Load Line for  $V_1$ .
- B: Crest Load Line for  $V_1$ .
- C: Crest Load Line for  $V_2$ .

## Carrier Tube—Carrier Condition

Expression 4, gives the calculated carrier load impedance of the carrier tubes for ideal conditions.

In practice,  $V_2$  will be allowed to contribute a small fraction of the carrier power and to effect this the output load resistance,  $R_L$ , is made slightly higher than the value of  $X$ . This small variation may be made during adjustment of the transmitter by tightening or loosening the load coupling.

Computation of carrier conditions of  $V_1$  for the load impedance of  $4 R_L = 2280$  ohms and  ${}^mE_p = 15400$  volts gives the data in Fig. 2, first column.

## Peak Tube

Computation of operating conditions for the peak tubes,  $V_2$ , begins from the fact that they are biased so as to begin delivering power to the load only when the carrier level is exceeded. Thus at carrier level it is necessary to have a negative bias equal approximately to the sum of the carrier-tube AC grid voltage amplitude,  ${}_{1c}{}^mE_g$ , and cut-off bias voltage for  $V_2$  at the crest of its carrier-level plate voltage,  ${}_{2c}{}^mE_p$ , which is determined by the impedance relations of the quarter-wave network connecting the plate circuits of  $V_1$  and  $V_2$  given by expressions (1), (2), and (3).

At carrier level since  $V_2$  is non-conducting, from (2) and (3)

$${}_{2c}E_p = \frac{1}{2} ({}_{1c}E_p) \quad (5)$$

$$= \frac{1}{2} (15400) = 7700 \text{ volts is the peak}$$

AC plate voltage of  $V_2$ . Thus a corresponding instantaneous voltage across  $V_2$  of

$(E_b - {}_{2c}{}^mE_p) = (17500 - 7700) = 9800$  volts obtains, for which the cut-off bias is found to be  $-280$  volts.

The second determining condition of  $V_2$  is that twice carrier power must be delivered into the load at 100 per cent modulation peaks. The positive-crest load impedance and voltages are:

$$\begin{aligned} {}_{2cr}Z_L &= 2R_L \\ {}_{2cr}E_p &= {}_{1c}E_p \end{aligned}$$

The grid bias voltage of  $V_2$  remains fixed at its carrier value.

Crest condition data for  $V_2$  as computed by the Chaffee method is shown in Fig. 2, fourth column.

## GRID CIRCUIT DESIGN

From the above it is seen that a grid excitation voltage rise above carrier cut-off bias equal to  $910 - (-290) = 1200$  volts is required. Since the modulated exciting voltage is impressed on the grid of  $V_2$ , a peak drive voltage on crests of twice this or 2400 volts must be applied.

To obtain linear operation of the amplifier, a carrier-level grid voltage of 920 volts is required on  $V_1$ . This voltage must rise to 1270 volts on modulation crests while that on  $V_2$  doubles from 1200 to 2400 volts. This variation may be obtained by terminating the phase-advancing quarter-wave network of Fig. 1, with a fixed loading resistance,  $R_1$ , in parallel with the variable AC grid input resistance,  $R_g$ , of tubes  $V_1$ . The constants  $X$  and  $R_1$  are determined as follows:

From,

$${}_{1c}E_g = {}_{2c}E_g \frac{R_1}{X} \quad (6)$$

is obtained,

$$X = \frac{{}_{2c}E_g}{{}_{1c}E_g} R_1 = \frac{1200}{920} R_1 = 1.3 R_1 \quad (7)$$

	V <sub>1</sub> (2 tubes)		V <sub>2</sub> (2 tubes)		
	Carrier	Crest	Carrier	Crest	
D-C Plate Voltage, E <sub>b</sub>	17500	17500	17500	17500	volts
D-C Grid Bias, E <sub>c</sub>	-480	-480	-1490	-1490	volts
A-C Plate Voltage, <sup>m</sup> E <sub>p</sub>	15400	15400	7700	15400	volts
A-C Plate Current, <sup>m</sup> I <sub>p</sub>	6.76	13.5	-----	13.5	amperes
Plate Power Output, P <sub>o</sub>	52	104	-----	104	kilowatts
D-C Plate Current, I <sub>b</sub>	4.15	8.48	-----	7.46	amperes
D-C Power Input, P <sub>b</sub>	72.5	148	-----	131	kilowatts
Plate Efficiency, N	72	70	-----	79.5	per cent
Plate Dissipation, P <sub>h</sub>	20.5	44	-----	27	kilowatts
D-C Grid Current, I <sub>c</sub>	0 approx.	0.23	-----	0.35	amperes
A-C Grid Current, I <sub>g</sub>	0 approx.	0.50	-----	0.76	amperes
A-C Grid Voltage, <sup>m</sup> E <sub>g</sub>	920	1270	1200	2400	volts
A-C Grid Excitation Power, P <sub>g</sub>	0 approx.	318	-----	910	watts
A-C Minimum Effective Grid Resistance, R <sub>g</sub>	-----	2540	-----	3160	ohms
Effective Plate Output Impedance, Z <sub>L</sub>	2280	1140	-----	1140	ohms

Fig. 2. Calculated Operating Data.

Since the total effective resistance terminating the grid network on crests

$${}_{cr}R = \frac{R_1 R_g}{R_1 + R_g} \quad (8)$$

while on carrier,  
 ${}_{c}R = R_1$

and also since,  
 ${}_{2cr}E_g = 2 ({}_{2c}E_g)$

we have from (6),

$$\frac{{}_{1cr}E_g}{{}_{1c}E_g} = 2 \frac{R_g}{R_1 + R_g} \quad (9)$$

But,

$$\frac{{}_{1cr}E_g}{{}_{1c}E_g} = \frac{1270}{920} = 1.38$$

Thus,

$$R_1 = 0.45 R_g \quad (10)$$

From Fig. 2, second column, it may be seen that the minimum AC effective grid resistance of V<sub>1</sub> at crest, R<sub>g</sub> = 2540 ohms, giving

$$R_1 = 1140 \text{ ohms} \quad (11)$$

Hence, from (7) we determine the network series and shunt reactances.

$$X = 1480 \text{ ohms} \quad (12)$$

With the determination of these constants the fundamental conditions for linear operation of the Doherty amplifier have been met.

The total maximum grid drive power required is the sum of computed values to V<sub>2</sub> and V<sub>1</sub>, plus the power consumed in R<sub>1</sub>. This latter is

$$P = \frac{({}_{1cr}E_g)^2}{2R_1} = \frac{(1270)^2}{2(1140)} = 700 \text{ watts}$$

Thus the total grid excitation power at crest equals,  
 ${}_{1cr}P_g + {}_{2cr}P_g + P = 318 + 910 + 700 = 1928$  watts.

. . . .

**References:**

- 1 W. H. Doherty, "A New High Efficiency Power Amplifier for Modulated Waves," *Proc. I. R. E.*, Vol. 24, No. 9, September 1936.
- 2 G. E. Strong and G. G. Samson, "An Experimental 5 Kw Doherty Amplifier," *Electrical Communication*, Vol. 16, No. 3, January 1938.
- 3 E. L. Chaffee, "The Operating Characteristics of Power Tubes," *J. App. Phys.*, Vol. 9, No. 7, July 1938.

# FILAMENT HEATING TRANSIENTS

## INTRODUCTION

OBSERVATIONS upon the transient effects in tungsten filaments contained herein are the result of considerable time and study expended expressly for the readers of this chapter. Much of the information is new and has not been available heretofore.

These observations provide some idea of the factors involved in reducing starting current surges in filaments of vacuum tubes. Up to the present, because theoretical equations applicable to the problem of large temperature changes have not been available, any approach to the heating time of tungsten filaments has been largely experimental.

## PRACTICAL CONSIDERATIONS

In practice the problem of filament starting transients is brought about by the fact that the hot or operating resistance of a tungsten filament at 2500°K. is approximately thirteen times its room temperature value. Operation of such a filament from a constant voltage source requires some type of limitation of the starting current to protect the filament structure from destruction by the large magnetic forces set up.

Devices commonly used to overcome this difficulty are high reactance filament transformers and starting resistances in series with the filament transformer primary circuit, which may be shorted out in one or more steps. In either case the starting current is usually limited to from twice to one and one half times normal operating current depending upon the tube structure.

The factors of chief interest in the design of these devices are the maximum current amplitudes obtained and the current-versus-time characteristic of the filament during the starting cycle.

The maximum starting current amplitude obtained from a constant voltage source will, of course, be determined by the total series impedance of the tube and source, that is, by the series resistance of the tube filament at the starting temperature and the resistance of connecting leads, plus the total internal impedance of the voltage source. From a knowledge of the first two constants for a given operating voltage and current, the internal impedance of the voltage source required to give the desired current limitation may be determined.

In the case of step-start systems, it is necessary to know in addition to the above information, how the filament starting current varies with filament temperature for a given applied voltage. It is desirable to know also, how the filament temperature varies with time after it has been connected to a voltage source of a given internal resistance.

## FILAMENT CIRCUIT DESIGN

The curves appearing in Fig. 1, show the relation between current and instantaneous temperature for a tungsten filament designed to operate at 2500°K. Curve A, gives this relation when rated voltage is applied to the filament, while B, gives it for half normal applied voltage. From these curves the desired operation of a two-step filament supply may be determined. Thus in following curve B, it is noted that the filament attains closely its maximum half-voltage stable temperature of 2000°K. at 60 per cent of rated voltage operating current. If at this point rated voltage is applied, an instantaneous current rise to 130 per cent of normal will be obtained as indicated by the difference in the ordinates of curves A and B corresponding to a temperature of 2000°K. Since a rise to 130 per cent of rated current is less than required, in order to reduce the heating cycle time the change-over from half voltage to full voltage is just obtained. For a point where the limiting current rise is just obtained. For two normal current this point is at ordinate c — c at 1400°K. This point enables the most rapid application of filament voltage within the required current limits.

Of course, in this case the current transient resulting from the application of half voltage across the cold filament, approximately 650 per cent of normal, is excessive since constant voltage supply sources only are considered here. Actually the series resistance of the voltage source on the half-step would be made, such as to limit the initial current to twice normal. In this case the filament would approach its half-voltage stabilization temperature along some curve lying below B.

A curve relating filament resistance with temperature has been plotted and is shown in Fig. 2. An illustration of its use in the design of a step-start filament supply follows.

Assume that a 20 volt, 50 ampere filament whose normal operating temperature is 2500°K. is to be started in two steps without exceeding twice rated current. The filament voltage supply has as its source a 20 volt transformer having a primary voltage of 220 volts. It is noted that by

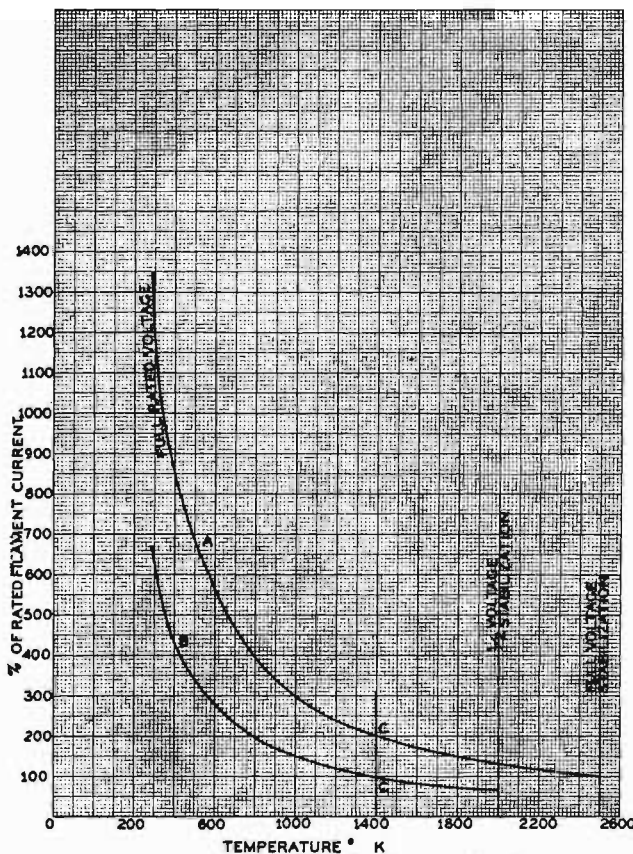

Fig. 1. Variation of Current with Temperature for Tungsten Filament for Half (curve B) and Full (curve A) Applied Voltage. Normal Operating Temperature = 2500° K.

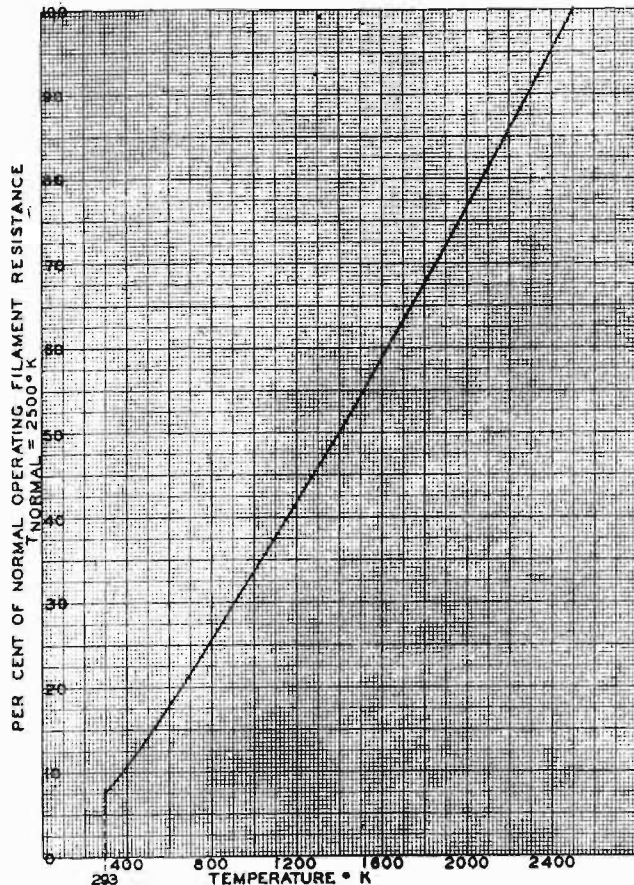

Fig. 2. Per Cent of Normal Operating Resistance (at 2500°K.) as a Function of Temperature for Tungsten Filament.

inserting series resistance equal to that of the filament at point c of curve B, Fig. 1, the rise in current upon shorting out the limiting resistance will equal exactly the twice rated current maximum permissible. It is also seen that the initial current maximum to the cold filament (293°K.) will equal rated filament voltage divided by the cold filament plus limiting resistance value.

Knowing that the normal operating resistance of filament at 2500°K. =  $\frac{20}{50}$  or 0.4 ohms, it is found that its resistance at 1400° and 293° from Fig. 2, to be 50 per cent and 7.4 per cent, respectively, of that value, or 0.20 and 0.03 ohms. The initial cold filament current surge will thus be  $\frac{20}{0.23} = 87$  amperes. The required series limiting resistance in the primary circuit =  $\left(\frac{220}{20}\right)^2 \times 0.2 = 24.2$  ohms.

The foregoing example represents the smallest value of series resistance which will give the desired limitation of starting current, and will thus result in the most rapid heating of the filament. Greater resistance than this may be used up to the resistance at the half-voltage stabilization temperature, in this case approximately 2000°K., but a somewhat longer heating cycle will be necessary.

The operation of a high reactance transformer in limiting filament surge current is similar in effect to that of the step-start resistance excepting that a continuous variation of the heating current is obtained without the necessity of shorting out primary resistance. The high leakage reactance drop of the transformer takes the place of the limiting resistance. Thus a filament transformer having 50 per cent impedance drop would give the same twice normal current limitation as the two step one half voltage start method described.

In practice it would seem that the initial current surge to the cold filament when voltage is first applied is considerably reduced by the inductive voltage drop because of the rapid rise of current at this point. This effect is indicated in the curves appearing in Fig. 4, where the calculated initial current maxima at  $t=0$  are 8.2, 4.8 and 2.6 times normal current for curves A, B and C, respectively, while the respective measured ratios are 3.7, 3.1 and 2.05. Thus it appears that even with a relatively low-reactance voltage source a current limiting effect is obtained.

### STABILIZATION TIME

The time required for a filament to obtain a given temperature after application of voltage is of interest in determining the length of heating cycle, dissipation of limiting resistors and timing of resistance shorting contractors. No precise method for the calculation of the heating time is available for direct application to this problem, but a discussion of the factors involved and their correlation with experimentally determined values may be useful.

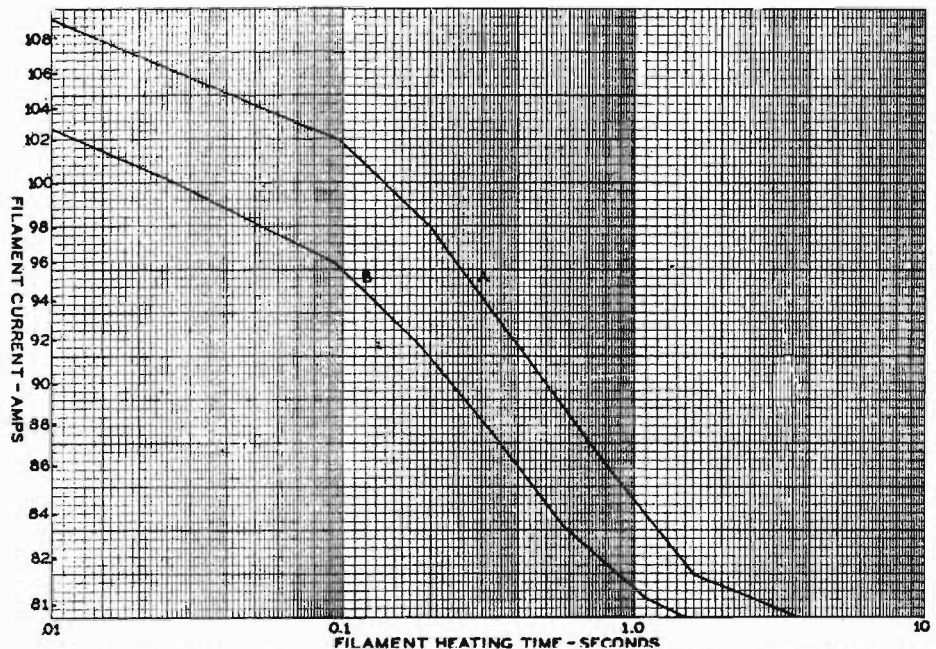

Fig. 3. Logarithmic Plot of Filament Current Versus Heating Time of F-116 Tube Filament. Filament Voltage Increased Suddenly from Half to Full Voltage at  $t=0$ . Series Resistance = 0.026 ohms.

# HANDBOOK OF TUBE OPERATION

A discussion of the problem of transient phenomena in heated filaments and the derivation of equations for their determination is given in a paper by Jones and Langmuir<sup>1</sup>, from which the following notes have been obtained. In this paper the following expression is given for the time,  $t$ , required for a filament operating at temperature,  $(T - \Delta o)$  to attain the temperature  $(T - \Delta T)$ , where  $\Delta o$  is the total temperature rise.

$$t = \frac{2.303}{a} \log_{10} \frac{\Delta o}{\Delta T} \text{ (seconds)}$$

in which

$$a = \frac{n_a W_a - n_w W_b}{HT}$$

where  $W_a$  is the watts electrical power input to the filament, and  $n_a$  the exponential power of its variation with respect to temperature;  $W_b$  is the watts energy radiated per second and  $n_w$  the exponential power of its variation with temperature;  $H$  is the heat capacity of the filament in watt seconds per degree.

While the above expression is applicable to tungsten filaments it gives accurate results only for relatively small values of  $\Delta T$  and  $\Delta o$ . The problem of sudden application of voltage to cool tungsten filaments involves large changes of  $T$ . Calculation, by means of this equation, of the stabilizing time for the filament of a Federal F-116A tube after increase from half to full voltage gives results approaching those obtained experimentally. Fig. 3, shows a comparison of the calculated current-versus-time curve with that obtained from oscillographic measurements. The temperature rise in this case is from  $2100^\circ$  to  $2500^\circ$ . Calculations involving larger temperature changes do not agree satisfactorily with measured results.

It is perhaps of interest to analyze the expressions for  $a$  and  $t$ .  $W_a = \frac{V^2}{R_1}$  is the power input to the filament, where  $V$  and  $R_1$  are the voltage across and the resistance of the filament at temperature  $T$ , and is equal to the power radiated,  $W_b$ .  $H$ , the heat capacity of a round tungsten wire filament is expressed by  $K d^2 l$ , where  $d =$  wire diameter and  $l$  the wire length. When an external resistance,  $R_2$ , is connected in series with the filament  $n_a = n_R \left( \frac{R_2 - R_1}{R_2 + R_1} \right)$ , where  $n_R$  is the exponential variation of filament resistance with temperature. Inserting these expressions in  $a$ , the expression for  $t$  may be written as

$$t = \frac{K'R_1 T d^2 l}{V^2 \left[ n_R \left( \frac{R_2 - R_1}{R_2 + R_1} \right) - n_w \right]} \log_{10} \frac{\Delta o}{\Delta T}$$

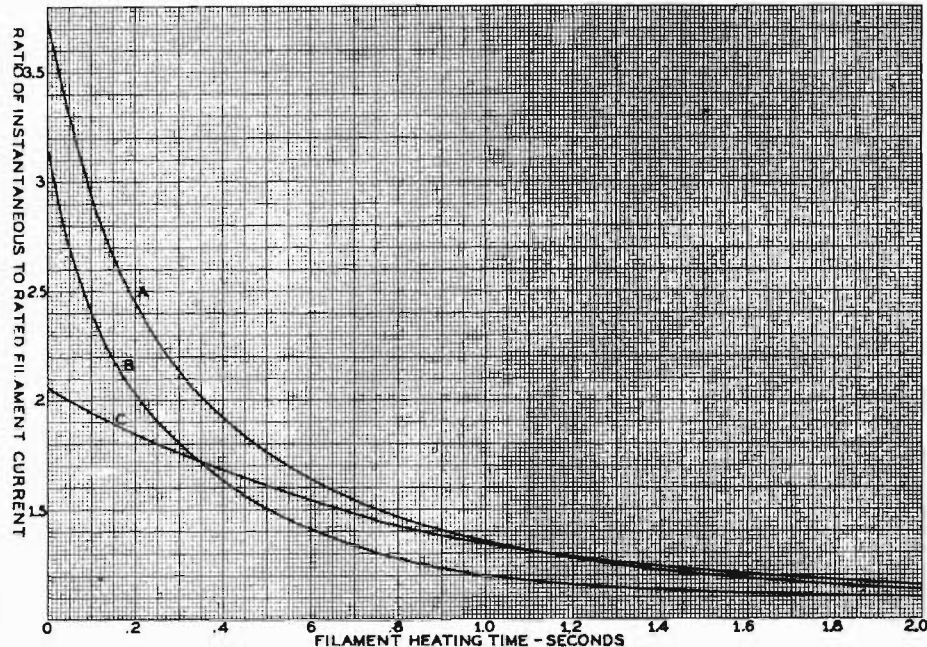

Fig. 4. Plot of Filament Current Versus Heating Time of F-320-B Tube Filament for Three Different Series Resistance Values.

- A: Series Resistance 0.026 ohms —  $E_f = 22.4$  volts.
- B: Series Resistance 0.084 ohms —  $E_f = 24.9$  volts.
- C: Series Resistance 0.267 ohms —  $E_f = 33.4$  volts.

It is seen that the time required to raise the temperature to  $(T - \Delta T)$  is directly proportional to the square of filament diameter, length, resistance and the logarithm of the total temperature rise to the temperature increment  $\Delta T$ . It is inversely proportional to the square of the applied voltage and the term

$$\left[ n_R \left( \frac{R_2 - R_1}{R_2 + R_1} \right) - n_w \right]$$

The latter term decreases with increase of series resistance  $R_2$ , hence the heating time is greater for larger values of series resistance.

Fig. 4, shows the current-versus-time curves for the 0.035" diameter tungsten filament of a Federal F-320-B tube for three different series resistances for a normal temperature voltage of 21.5 volts. Curves A and B, correspond to connection to low internal impedance voltage sources, while curve C corresponds to operation from a source having an internal resistance equal to 50 per cent that of the hot resistance of the tube. In spite of the open circuit voltage of the filament transformer being equal to 33.4 volts, it is seen that the initial current amplitude is only slightly in excess of twice normal current. These curves were obtained from actual oscillographic measurements.

#### Reference:

1. Jones and Langmuir, G. E. Review, June, July, August, 1937.



# MULTIPHASE FILAMENT OPERATION

**M**ULTIPHASE filaments in transmitting tubes were introduced to the industry a few years ago as a result of the trend toward complete alternating-current operation of transmitting equipment. Two principal advantages were claimed for them: a balanced load on the power lines and a lower hum level. The increase in the power of transmitters with the attendant increase in the size of tubes has added to the appeal of these arguments.

Experience with the operation of transmitting tubes employing multiphase filaments has revealed that one of these reasons is actually false and that there are disadvantages which far outweigh the remaining one.

## HUM MODULATION

The most important of the advantages claimed for multiphase filament operation with the current emphasis on high-quality, low-noise-level transmission is that of reduction in the level of the hum modulation due to filament heating current. Such modulation is caused almost entirely by the magnetic field of the filament. Since this field increases with the magnitude of the filament current it would be expected to assume greater importance as the size of the tube increases.

It was for this reason that an investigation was carried out at Federal to determine the relative hum modulation due to filament excitation to be expected from different types of power tubes under various operating conditions. A series of measurements was made with the tubes in a self-excited oscillator operating on approximately 520 KC. The plate supply consisted of a three-phase, full-wave rectifier with sufficient filter to give a plate voltage ripple 70 DB below the rectifier DC voltage output. Hum modulation of the carrier was measured with a General Radio Type 731-B modulation monitor using an external 50 ua meter in series with the 600 ua meter contained in the monitor. The instrument was calibrated for the new low range. Carrier modulation as low as 70 DB below carrier can be read quite accurately by this method. The hum modulation for each type of tube was measured over wide ranges of plate voltage, plate current, grid bias, and grid swing. In the case of multiphase filament tubes, measurements were made with single phase, three-phase, and six phase filament excitation.

The data obtained show a good correlation between hum modulation and grid saturation. Examination of the data suggested that if a convenient measure of the degree of grid saturation could be set up it would be possible from similar data for a given type of tube to predict the hum modulation due to filament excitation for any set of operating conditions.

The region of grid saturation may be defined as that portion of the tube characteristic in which with a constant load impedance a positive increment in grid voltage results in either no change or a decrease in plate current. This mode of operation produces a plate current pulse having a flat top or dip at the crest. Inspection of constant current curves for various tube types shows that although the region of grid saturation varies somewhat depending on the design characteristics of the tube type, it is always quite close to the diode line. Therefore, if we assume that the diode line represents the point of maximum grid saturation for any plate voltage and load impedance, we may say that the ratio of the length of the operating line under any given condition to the length of an operating line of the same load impedance extending to the diode line is a measure of the degree of grid saturation for that condition. While this assumption is only approximate it was found to give a reasonably satisfactory means of predicting hum modulation for any selected mode of operating.

Total hum modulation as measured under a wide range of operating conditions for each tube type under consideration was plotted against the degree of grid saturation. The results for multiphase-filament types F-898 and F-124-A are shown in the total hum modulation curves, Fig. 1. Inspection of these curves indicates that with these two different types of multiphase filament structure, when operating in the region of grid saturation, the hum modulation is reduced by approximately 2.5 DB by the use of three-phase rather than single-phase filament excitation. The type F-124-A will give an additional 2.5 DB reduction in hum modulation when six-phase is substituted for three-phase filament excitation.

While this data does show some reduction in the measured hum modulation level by the use of multiphase filament excitation, the sensitivity of the human ear and the characteristics of the receiving equipment affect the ultimate result. Ear sensitivity is concerned with the least intense sound that can be heard. Such a sound is said to be at the "threshold of hearing". The principal hum modulation frequencies caused by single-phase, three-phase, and six-phase filament excitation are normally 120, 360 and 720 cycles per second, respectively. Published data on the average human ear indicates the following "threshold of hearing" levels in terms of DB above a reference level of  $\phi$ DB at 800 cycles per second, corresponding to a level of  $10^{-6}$  watts per square centimeter.

720 cycles per sec.	1 DB
360 cycles per sec.	10 DB
120 cycles per sec.	30 DB

From this it is apparent that the hum level due to single-phase filament excitation can be 20 DB higher than for three-phase, and 29 DB higher than for six-phase, without being more audible to the human ear. Inasmuch as the greatest measured difference in hum level at 100% grid saturation is in the order of 5 DB, the effective audible hum level is actually lower in the case of single-phase filament excitation. These results assume the use of perfect receiving equipment capable of reproducing all frequencies equally. In actual practice the average receiver will respond to 360 or 720 cycle modulation much better than to 120 cycle with the result that the lower frequency is still discriminated against.

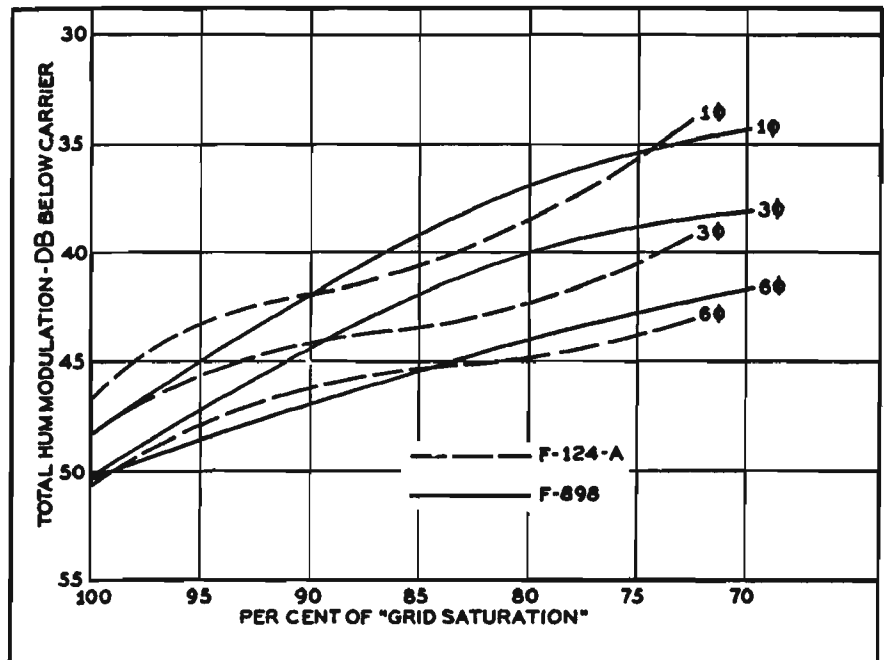

Fig. 1  
Typical curves showing total hum modulation as a function of grid saturation.

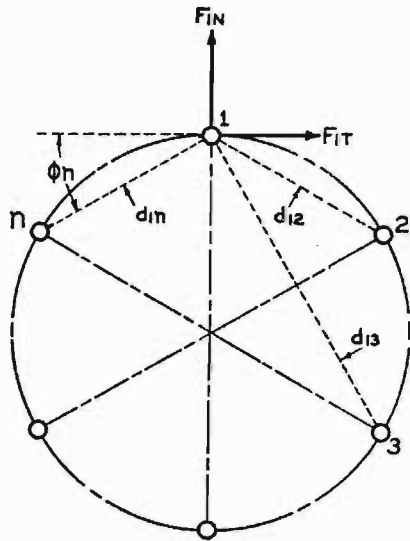

Fig. 2

Diagram of the forces acting upon a multiphase filament.

Present day operating practice can be counted upon to lessen still further the need for multiphase operation in so far as hum modulation is concerned. In many cases the quadrature connection of the filaments of two tubes each operated single-phase and used in parallel or push-pull will result in further reduction of the resulting hum modulation.

This precaution should be observed in cases where the plate load impedance is negligible for the hum frequencies as would be the case for radio-frequency amplifiers. Where this condition is not met as in the case of push-pull audio applications, the filament voltages of the two tubes should be in phase since cancellation can then take place in the plate circuit. In class B audio applications this hum cancellation is realized under the conditions of zero signal where it is most important. On the basis of this data and considering that the present-day practice of using overall inverse feedback on fixed-frequency transmitters has further reduced the hum modulation, the type of filament excitation employed is no longer a determining factor in the final carrier hum modulation.

## MAGNETIC FORCES ON FILAMENTS

One of the limitations on the life of a transmitting tube filament and consequently on the life of the tube is its ability to withstand the forces to which it is subject. These forces are of three kinds: electrostatic, magnetic, and mechanical. Electrostatic forces are usually of important magnitude only in the case of high voltage thermionic rectifiers where the difference in potential between the filament and the anode is twenty thousand volts or more. In the case of the conventional triode, the grid-filament potential rarely exceeds a few thousand volts and as a consequence the electrostatic force on the filament strands is negligible. Forces between filament strands and filament sections due to the magnetic fields set up by the filament heating current can, however, very easily reach destructive magnitudes.

The magnitude of the total force in grams between two filament strands of length  $l$  centimeters, spaced  $d$  centimeters and carrying instantaneous current amplitudes  $i_1$  and  $i_2$  amperes, is given by the expression:

$$f = 2.04 i_1 i_2 \frac{l}{d} \times 10^{-5} \quad (1)$$

It is apparent from the above expression that for equal currents, strand forces increase as the square of the heating current amplitude. These forces may become of great importance in high-power output, long-life tubes having a high filament-input power. Such multi-strand filaments must be designed so that magnetic forces on the filament strands are sufficiently small in magnitude as to cause no appreciable deformation. This is accomplished, in general, by a symmetrical placement of the filament strands and electrical connections such that the net resultant force on any one strand due to the magnetic fields of all other strands is essentially zero.

As an example, consider a filament consisting of an even number of parallel filament strands equally spaced around the axis of the tube. Such an arrangement is shown diagrammatically in Fig. 2. For this configuration a simple expression for the tangential force  $F_t$  in grams per centimeter length, on a given strand may be obtained.

$$F_t = 2.04 \times 10^{-5} \times i_1 \left\{ \frac{i_2}{d_{12}} \cos \phi_{12} + \frac{i_3}{d_{13}} \cos \phi_{13} + \dots + \frac{i_n}{d_{in}} \cos \phi_{in} \right\} \quad (2)$$

where  $i_1$  is the current in amperes in the investigated strand and  $i_n$  is the current in the  $n$ th strand and  $d_{in}$  is the distance in centimeters between strands 1 and  $n$ .  $\phi_{in}$  is the space angle between a line through strands 1 and  $n$  and the tangent to the filament structure at strand 1. From inspection of equation (2) it is apparent that for equal but opposite direct current in adjacent strands, the resulting tangential forces on all strands are equal and approach zero.

The expression for the outward normal force,  $F_n$ , on a strand is

$$F_n = 2.04 \times 10^{-5} \times i_1 \left\{ \frac{i_2}{d_{12}} \sin \phi_{12} + \frac{i_3}{d_{13}} \sin \phi_{13} + \dots + \frac{i_n}{d_{in}} \sin \phi_{in} \right\} \quad (3)$$

Inspection of this equation and Fig. 2 indicates that the outward forces exerted under the same conditions as considered above are equal on all strands and negligibly small.

If, in the above expressions, we use effective values of alternating current, the resultant forces will be the same. Similarly if we introduce the phase angles of the currents in the various strands we find that for symmetrical three- and six-phase filament structures where the phase sequence of strand currents progresses uniformly around the circumference, the tangential forces on the filament strands are in equilibrium and the normal force components are again equal and relatively small. We can conclude from this analysis that the type of filament structure considered is inherently mechanically stable for direct current, single-phase, three-phase and six phase operation so long as the strand currents are of equal magnitude and the phase sequence uniform around the circumference. It becomes of utmost importance, therefore, to make the proper filament terminal connections for any type of filament heating power.

## MECHANICAL FORCES ON FILAMENTS

Mechanical forces may be set up in a filament for a variety of reasons. Uneven heating or cooling rates for different parts of the structure may result in forces being set up which will stress the filament strands beyond their elastic limit. Other causes will be apparent upon examination of typical structures.

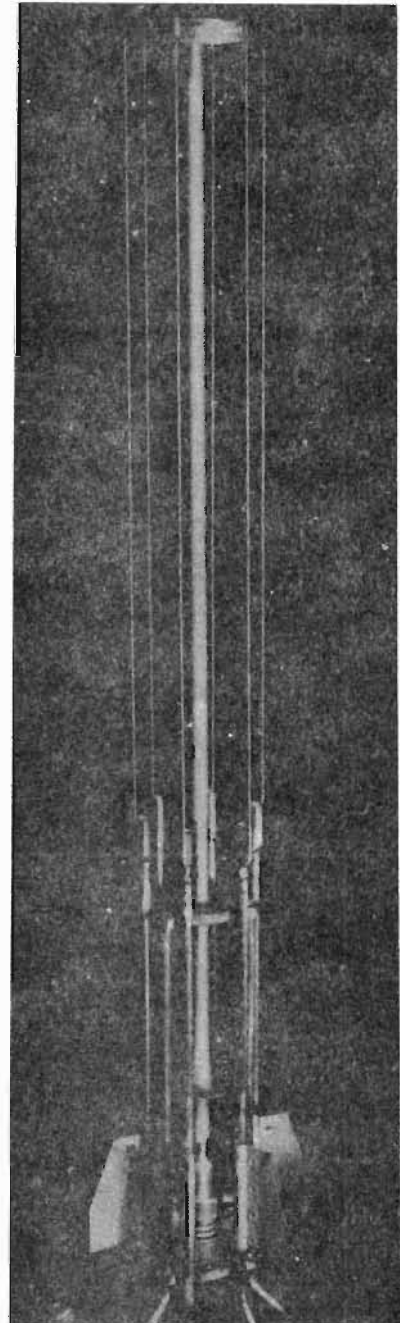

Fig. 3

Type F-893 filament mount showing typical single-strand construction.

There are in use two principal types of multiphase filaments. The first type, historically, is represented by the structure used in the types 893 and 898 tubes and is illustrated in Fig. 3. Six symmetrically-placed filament strands are fastened to a center support rod at one end. A compression spring acts through the center support rod to keep the filament strands under slight tension at all times. Great care must be taken in the assembly of this structure to assure equal tension and equal length in all filament strands. The diameter of each strand must be very accurately matched, so that in operation the filament strands will reach the same operating temperature and hence will all expand an equal amount. Obviously, if one filament strand should expand a greater amount than the other strands, mechanical forces will be set up within the filament structure resulting in deformation of one or more strands.

So far only the manufacturing precautions necessary to minimize the mechanical forces with this type of filament structure have been discussed. Probably the most destructive forces to be encountered, however, are those resulting from unequal filament strand currents and improper phasing of the currents in the various strands. The unequal strand currents will not only cause resultant magnetic forces which may be large, but will cause unequal strand expansion due to the difference in operating temperature. Since the strands are all fixed rigidly at both ends relative to one another, they are unable to expand independently. The resultant mechanical forces must, therefore, relieve themselves by deformation or breakage of one or more strands or by the shift of the entire filament structure from its vertical axis. Once a strand is deformed, the magnetic forces are no longer in equilibrium. In addition, subsequent heating and cooling cycles of the filament keep increasing the mechanical stress in the structure with the eventual result of a broken filament strand or a grid-filament short. Any tendency for filament strands to evaporate at unequal rates during life and hence to become unequal in diameter will aggravate this condition. It should be noted that the same situation exists for this particular structure for single-phase or even d-c excitation as for three- or six-phase.

The other principal type of multi-phase filament, represented by the structure used in the Federal F-124-A tube was designed to overcome those difficulties and is illustrated in Fig. 4. Six symmetrically placed folded strands are used. Inasmuch as the folded strands, or hairpins, are rigidly mounted at only one end of the structure and the closed end of the hairpin is simply guided by an elongated loop that is electrically insulated from the center support structure, each hairpin is free to expand independently of the others. This type of multiphase structure, while more expensive to build, has the outstanding advantage of completely eliminating the problem of mechanical forces set up within the structure due to unequal expansion of the individual elements.

Uniform phase progression cannot be attained for multiphase operation with this type of filament structure. A phase sequence can be chosen, however, such that the maximum stress on any strand is well within safe operating limits. Calculation of the deflection of the filament used in the F-124-A tube indicates a maximum tangential strand displacement of only  $10^{-4}$  mm. As in the case of the first filament structure described it is vitally important that the various strand currents be maintained very nearly equal in order to keep the resultant magnetic forces at a safe value. When this structure is operated single-phase, however, the tangential magnetic forces are balanced, and its freedom from expansion difficulties makes it an extremely rugged filament.

## EFFECT OF PHASE UNBALANCE

Experience has shown that the normal variation between phase voltages on the average power line is of sufficient magnitude to reduce materially the life of a multiphase filament unless elaborate means for continuously maintaining accurate phase voltage balance are provided. Means must also be provided for the immediate removal of filament power in the event of failure of one phase of the power line.

The single strand type of filament structure as used in the type 893 tube requires that the phase voltages shall not differ by more than 0.5% if maximum tube life is to be obtained. The hairpin type of filament as used in the Federal-124-A tube will permit a maximum phase unbalance of 1%.

When either of these types of filament is operated with single-phase filament power, the difficulties with phase unbalance are eliminated. In order to realize this advantage, however, it is important that good connections be made to the filament terminals. If poor contact exists on

any terminal the current into that terminal will be reduced and the effect will be the same as for unbalance in multiphase operation. It is obviously also important, as has been pointed out, that the proper terminal connections be made. Experience has shown that when a filament structure which is designed to allow individual expansion of the filament strands is operated single-phase with proper observance of these precautions, greatly improved life results as compared to multiphase operation or to the older type of structure. Even the older type which does not allow free expansion of individual strands will show longer life when operated single phase because of the elimination of the difficulty of phase unbalance.

## LOAD ON POWER LINE

The second advantage claimed for the multiphase filament operation was that of balancing the load placed upon the power lines. If in the usual transmitter with its several power supplies and separate stages, consideration is given to distributing the various components of the load between phases, it will usually be possible to effect satisfactory balance. Compared to the economic advantages of increased tube life to be expected from single-phase operation, the argument for balancing filament supply load seems insignificant.

## SUMMARY

The advantages of single-phase over three or six-phase operation of high power tube filaments may be summarized as follows:

1. Single-phase operation results in longer life expectancy because of the elimination of the magnetic and mechanical forces resulting from phase unbalance.
2. The effective audible level of hum modulation is actually lower for single-phase operation.
3. The cost of the additional protective measures necessary with multiphase operation is eliminated with single-phase operation.
4. There is less danger of improper filament connection for single-phase operation than for multiphase.
5. By proper attention to dividing the various parts of the total transmitter power load among the power supply phases, any effect of unbalance due to filament supply can be eliminated.

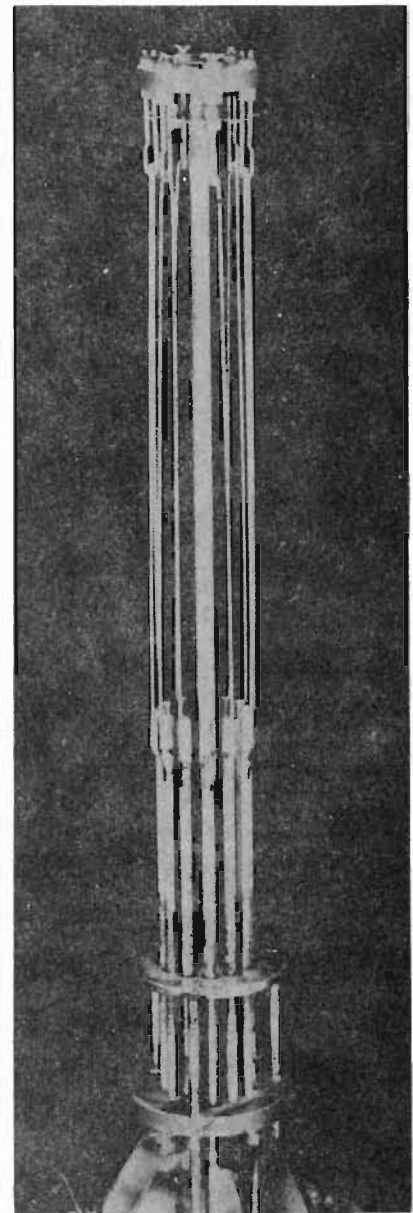

Fig. 4

Type F-124-A filament mount showing typical folded-strand construction.

# FORCED-AIR COOLED TUBES

## INTRODUCTION

UP until the last few years, water-cooling has been applied almost exclusively to high power radio tubes. The high unit area dissipation and low anode operating temperature obtainable, offered the tube engineer the advantages of a simplified tube structure. With the development of new tube materials, manufacturing processes, and the improvement of glass-to-metal seals, the technical basis for the introduction of a contact-cooled tube, operating at higher anode temperatures, was made possible.

## CONSTRUCTION AND APPLICATION

Briefly, the forced-air cooled tube consists of an external-anode tube of more or less standard design mounted in a cooler unit to which it is joined by means of a thin solder joint of high thermal conductivity. Through the radial fins of this unit an axial flow of high velocity cooling air is forced by a blower. In the type of tube under discussion, the cooler design is such that the required air flow may be obtained at a very low static pressure allowing a simple low head type rotary fan to be used.

The main difference between the water cooled and forced-air cooled tubes are their effective anode cooling areas and anode operating temperatures. Thus, the water cooled tube may dissipate between 200 and 700 watts per sq./in. at anode temperatures roughly between 30°C. and 70°C., whereas the corresponding respective values for the forced-air cooled tube are 3 to 4 watts per sq./in. at 150°C. to 200°C. From these figures it might seem that the required air cooling anode assembly would be of prohibitively large dimensions. In practice, however, through the use of a large number of thin fins and high air velocities, the unit is comparable in size to the water cooled tube with its water jacket and associated piping.

In many cases, forced-air cooling may have advantages over water cooling. The problems of electrolysis, water purification, power losses through the cooling water column and maintenance of insulating hose reels and tubing, are largely eliminated. The upkeep and investment in auxiliary apparatus, such as elaborate heat exchanger systems, are greatly reduced, owing to the simplicity of this equipment for air cooling systems.

The radio or audio frequency performance characteristics of corresponding types of forced-air cooled and water-cooled tubes are inherently the same when the maximum air-cooled dissipation rating is taken into consideration. While an air cooler may be designed for economical operation for the full water cooled anode dissipation range, it is advantageous to limit its design to the normal maximum requirements. Thus, since the application of high efficiency Class B and C amplifier operation is becoming general in modern transmitters, the maximum dissipation has been taken as the nominal value encountered in these circuits for the rated output of the tube. From the characteristics of

forced-air cooled tubes, as shown below, it is seen that dissipation above the rated maximum, comparable to that of water cooled tubes, might be safely used if the required increase in air flow were supplied. However, since this additional flow for the same cooler design results in excessive air velocity with reduced cooling efficiency and increase of objectionable air noise, it is preferable to adopt a larger cooling assembly if additional dissipation capacity is necessary.

Service life for both types of tubes is primarily determined by the evaporation rate of their tungsten filaments. The most important secondary limitation in either case is abnormal anode dissipation. In the case of water-cooled tubes excess dissipation results in boiling of the water with formation of bubbles on the anode and consequent danger of anode puncture. In forced-air cooled tubes, the overloading phenomena is different since such discontinuities in the cooling medium are not created. High anode temperature may result in melting of the film of solder between the anode and cooler surfaces with resulting crystallization or chemical decomposition and impairment of its thermal conductivity; hence, a maximum anode operating temperature considerably below this critical value is specified.

The question confronting the radio engineer as to whether he should use forced-air cooled tubes in a particular installation will in most cases be decided by economic considerations. For normal transmitter locations in temperate regions of average ambient temperature range, particularly in arid regions where the cooling water supply represents a serious problem, installation and operating costs for a forced-air cooled system will be considerably lower than in the case of water cooling. In regions of extremely high sustained temperatures, such as the tropics where extensive air conditioning equipment may be required, and for special applications, water cooling may be cheapest. A brief summary of the major design factors involved may assist the user to safely obtain maximum operating efficiency of forced-air cooled tubes.

## DESIGN FACTORS

The expression used in water cooling system design, that 264 watts, may be dissipated per degree centigrade rise per gallon per minute flow, has its counter part in forced-air cooling problems. From the expression

$$Q = 5.92 (t_i + 273) \frac{P}{\Delta t}$$

where  $P$  = the kilowatts dissipated,  
 $\Delta t$  = the air temperature rise in  $^{\circ}\text{C}.$ ,  
 $t_i$  = the air intake temperature in  $^{\circ}\text{C}.$ ,  
 $Q$  = the air flow in cu./ft./min.,

we see that the analogous rule is that 576 watts may be dissipated per degree centigrade cooling air temperature rise per thousand cubic feet per minute air flow. We note, however, that in contrast with the water cooling case, this value is accurate only for a single air intake temperature  $T_i = 20^{\circ}\text{C}.$  For  $T_i = 50^{\circ}\text{C}.$  the corresponding power dissipation capability will become approximately 520 watts. This expression enables us to determine calorimetrically the applied anode dissipation. In making such measure-

for each design of radiator giving permissible values of,  $Q$ ,  $P$ ,  $t_i$ , and,  $\Delta t$ . Fig. 1, shows such a characteristic for the Federal F-124-R and F-125-R<sup>1</sup> forced-air cooled tubes in which,  $P$ , the plate dissipation in kilowatts is plotted versus,  $t_i$ , the intake air temperature in degrees centigrade with the rate of air flow in cubic feet per minute,  $Q$ , as a parameter, for the designed safe maximum anode temperature of  $200^{\circ}\text{C}.$  From these curves it is possible to determine the cooling air requirements for any particular installation. It is apparent in using the chart that an intake air temperature equivalent to the maximum seasonal ambient temperature must be taken as the basis of calculation in determination of the required air flow and fan capacity, unless air conditioning equipment for maintenance of a lower cooling air temperature is provided for. Inspection of Fig. 1, indicates that for a given plate dissipation the

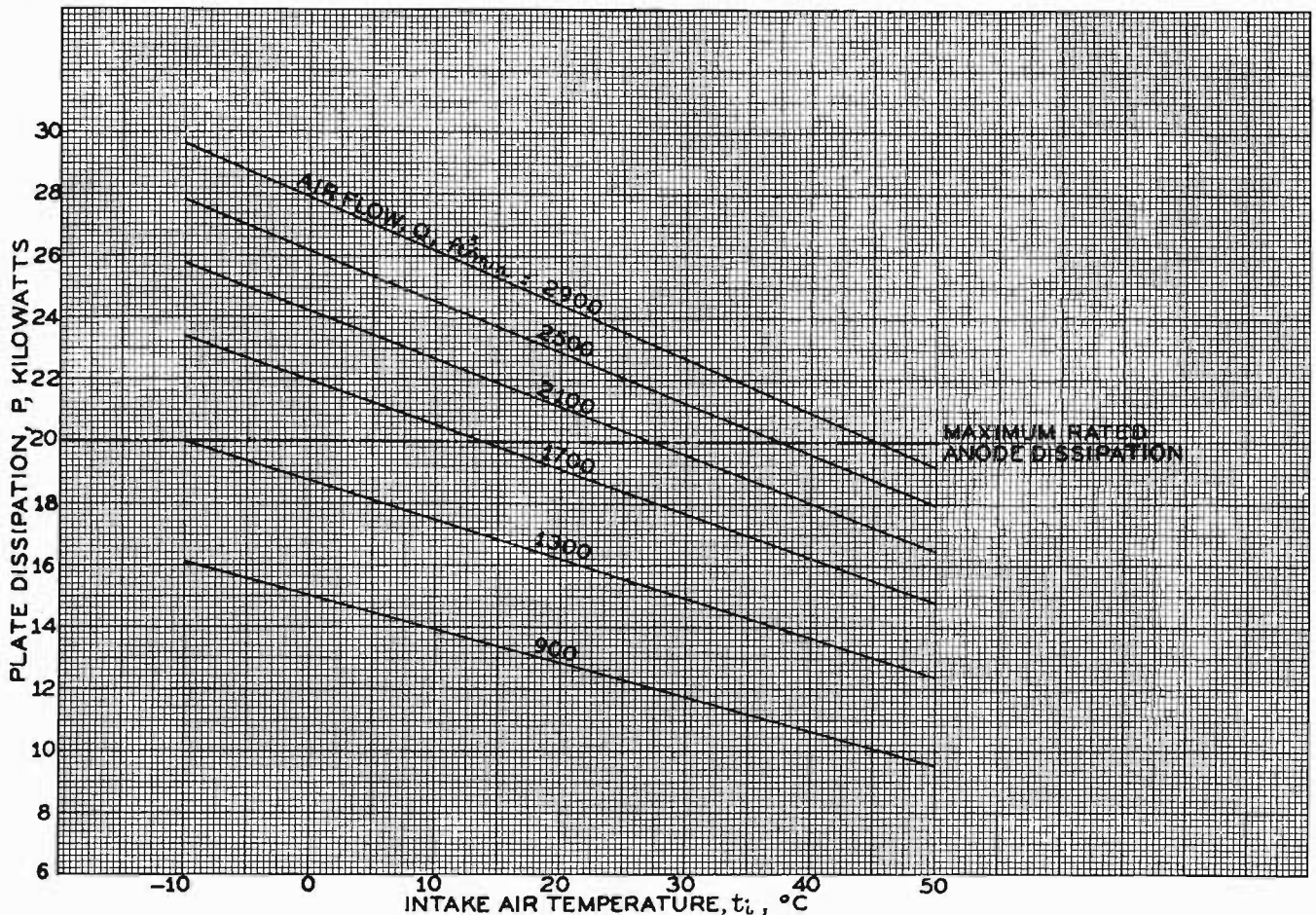

Fig. 1  
 Cooling Characteristics of Type F-124-R and F-125-R Forced-Air Cooled Tubes for Maximum Anode Temperature,  $T = 200^{\circ}\text{C}.$

ments, precautions must be taken that the true average rate of air flow and average temperature rise are measured, a somewhat more difficult problem in practice with existing equipment than for water measurements.

The thermal design of an anode cooler is such that at a given air flow,  $Q$ , intake air temperature,  $t_i$ , and air temperature rise,  $\Delta t$ , a corresponding maximum anode temperature,  $T$ , obtains. This maximum value of,  $T$ , as noted above, represents the safe operating limitation of the particular anode design. Cooling charts have been calculated

air flow required increases rapidly for the higher values of intake temperature. It is apparent that considerably more efficient cooling may be obtained at the lower ambient temperatures.

The air temperature rise,  $\Delta t$ , for a given condition of operation for the above type of tubes, is shown for the intake air temperatures,  $t_i$ , of  $20^{\circ}\text{C}.$  and  $50^{\circ}\text{C}.$  in the curves of Fig. 2. In both Figs. 1 and 2, net plate dissipation values are shown, exclusive of the filament power dissipated.

# HANDBOOK OF TUBE OPERATION

In connection with the use of the curves, a difference between the cooling requirements of water cooled and forced-air cooled tubes is to be noted. In the specification of cooling requirements for water cooled tubes of a given design and using a given water jacket, a minimum value of water flow is specified regardless of the actual anode dissipation applied. This requirement must be made in order to assure a uniform water film of axial velocity sufficient to eliminate the possibility of bubbles and air pockets. Thus, when operating at reduced dissipation, a corresponding reduction of water flow is not permissible. In the case of forced-air cooled tubes this condition does not exist

the proper disposition of air flow is effected by provision of different size fans or by proper proportioning of the respective air ducts, the overall economy in cooling equipment capacity is apparent.

## CONCLUSION

In the above, an attempt has been made to bring out the major factors of forced-air cooled tube design and such operating limitations as may be of interest to the transmitting station operator. A comparison has also been made between water cooled and forced-air cooled tube characteristics. For a more detailed discussion of forced-air cooled

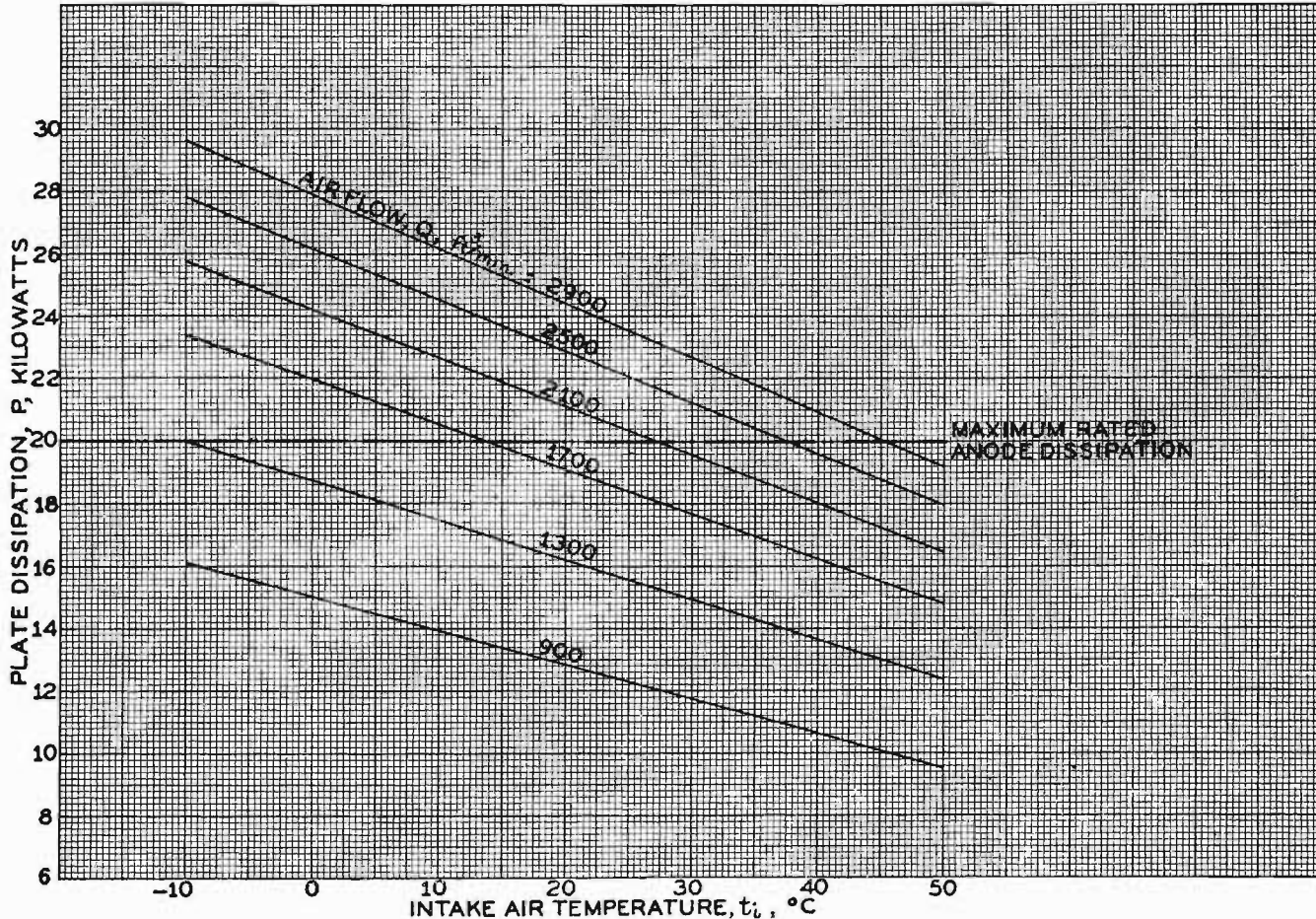

Fig 2 Cooling Characteristics of Types F-124-R and F-125-R Forced Air Cooled Tubes for Intake Air Temperatures,

$$t_i = \begin{cases} \text{Solid line, } 50^\circ\text{C.} \\ \text{Dash line, } 20^\circ\text{C.} \end{cases}$$

owing to the uniformity of the cooling medium flow over the air velocity range used. Thus, forced-air cooled tubes may be operated at an air flow corresponding to their actual operating dissipation as determined from Figs. 1 and 2. This fact may effect considerable economies where similar tubes in the same transmitter operate at different anode dissipations. In the Doherty high efficiency type amplifier for instance, where the peak tubes operate at very low dissipation, the air flow to these tubes may be adjusted to a fraction of that of the carrier tubes. A similar situation may exist between the modulator and RF amplifier tubes of a high efficiency plate modulated transmitter. Whether

tube design, the reader is referred to recent articles on this subject<sup>2,3</sup>.

Forced-air cooled tubes offer the radio transmitter engineer an alternative solution to his large power tube problems, which may offer considerable economies in investment, maintenance and operating costs.

### References:

1. March, 1940, issue of TUBES.
2. M. van de Beek, "Air Cooled Transmitting Valves," Phillips Tech. Rev., Vol. 4, No. 5, May, 1939.
3. E. M. Ostlund, "Air Cooling Applied to External-Anode Tubes," Electronics, June, 1940.

# GRAPHICAL DESIGN OF FREQUENCY MULTIPLIER AMPLIFIERS

## PART ONE

### INTRODUCTION

WHILE short cut graphical and analytical methods have been extensively developed for the more frequent applications of vacuum tubes as audio frequency amplifiers, modulators, and conventional modulated or unmodulated radio frequency amplifiers, less attention has been directed toward analysis of their more specialized applications.

The aim of this chapter is to outline a graphical method for the computation of operating characteristics of triodes when used as frequency multiplier amplifiers or harmonic generators.

The approximate analytical method given by Terman<sup>1</sup>, while very rapid and convenient for approximate design, may not give sufficiently accurate results, particularly if the grid current is of special interest as for instance in the case of the plate modulated harmonic amplifier. The exact analytical method of Prince<sup>2</sup> may be used, but is rather cumbersome for practical use. The method set forth here is somewhat simpler due to the largely graphical determination of plate and grid currents directly from the constant-current characteristics of the tube by means of a sine scale.

### METHOD

The general method is essentially the same as that outlined by Chaffee<sup>3</sup> for the computation of the characteristics of conventional Class C amplifiers. Having given the constant-current characteristics of the tube we have a graph of the instantaneous plate and grid currents as a function of the instantaneous grid and plate voltages.

In the case of the conventional Class C amplifier, since the applied alternating grid voltage and the alternating voltage across the plate resonant circuit are of the same frequency, the grid and plate current values corresponding to a given time,  $t$ , may be directly determined from the constant-current characteristics. The locus of simultaneous grid and plate voltage values is here a straight line drawn between the two points determined by the peak alternating voltage values and their zero values.

The frequency multiplier considered here is essentially a Class C radio frequency amplifier having its plate resonant circuit tuned to a multiple of the grid exciting frequency. Since the grid and plate voltages here are of different frequency as shown in Fig. 1, the grid and plate currents cannot be found directly since the locus of simultaneous grid and plate voltages is a curve whose shape is dependent upon the grid-plate frequency relation and the current conduction angle of the plate circuit. This curve may be plotted quite easily by means of a simple relation between the instantaneous grid and plate circuit electrical angles,  $\theta_g$  and  $\theta_p$ , respectively, and the use of a sine scale.

Graphical harmonic analysis may now be applied to the determined curves of current versus voltage, giving the average direct and fundamental frequency alternating

grid currents and the average direct and harmonic frequency alternating plate currents. From these data harmonic power output, DC power input, plate dissipation, efficiency, and plate load impedances are determined. Likewise, the grid drive power and grid dissipation may be obtained from the grid data.

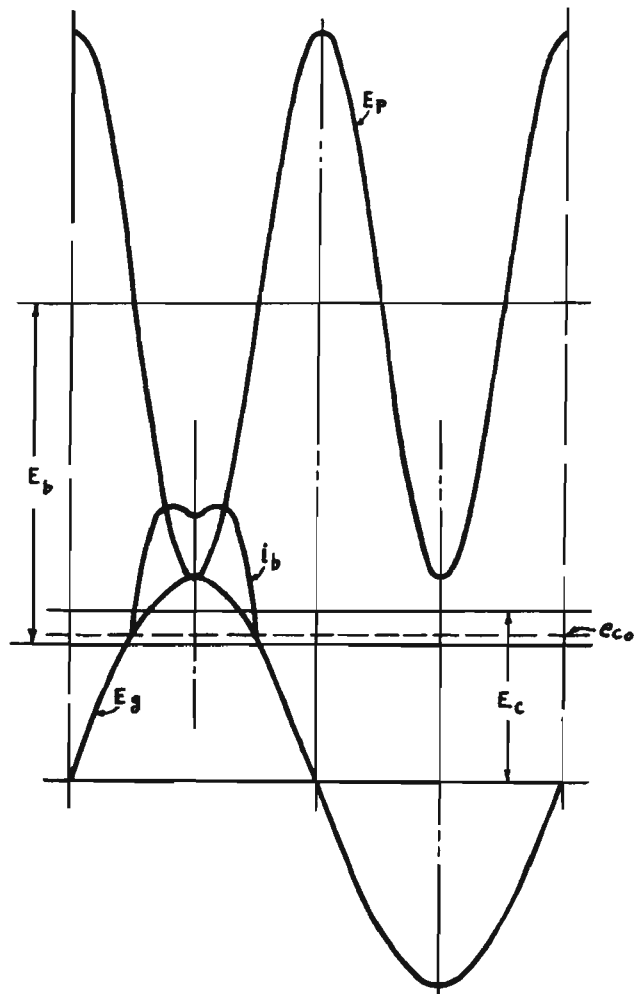

Figure 1. Current-Voltage Oscillograms for Doubler.

## GRID-PLATE ANGLE RELATION

From Fig. 2, it is apparent that in addition to the alternating plate load voltage frequency being a multiple of the grid circuit frequency, the fixed phase angle between them is determined by the relation of their frequencies. For grid and plate angular frequencies,  $\omega_g$  and  $\omega_p$  and grid and plate instantaneous electrical angles,  $\theta_g$  and  $\theta_p$ , respectively, since:

$$\omega_g = \frac{\omega_p}{n}$$

we see from Fig. 2, that the instantaneous plate angle may be expressed in terms of the grid angle as

$$\theta_p = \frac{\theta_g}{n} + \frac{\Phi}{n} \quad (1)$$

where  $n$  equals the order of the harmonic frequency with respect to the fundamental frequency.

Since the maximum values of plate and grid voltages are simultaneous when maximum plate current is conducted

$$\sin \theta_g = \sin \theta_p = 1$$

that is

$$\theta_g = \theta_p = \frac{\pi}{2}$$

Thus from (1)

$$\frac{\theta_p}{n} + \frac{\Phi}{n} = \frac{\pi}{2}$$

and hence

$$\Phi = \frac{\pi}{2} (n - 1) \quad (2)$$

Substituting (2) in (1) we get the general expression for the grid plate angle relation,

$$\theta_g = \left[ \frac{\theta_p}{n} + \frac{\pi}{2n} (n - 1) \right] \quad (3)$$

## GENERAL PROCEDURE

The approach to the design of a frequency multiplier amplifier will depend upon what fixed operating conditions are assumed. In many cases, particularly for lower amplification factor triodes, the maximum permissible grid bias must be adopted in order to obtain a plate conduction angle which will give optimum harmonic output with good plate efficiency.

Maximum harmonic output for a given plate input neglecting other considerations occurs for a plate current conduction angle approximately equal to a half cycle of the plate load voltage frequency. Plate efficiency, of course, increases with decrease of this angle.

For illustration assume as fixed, the plate supply voltage,  $E_b$ , and the plate conduction angle,  $B$ . For the particular triode used an alternating plate load voltage amplitude,  $ME_p$ , is assumed such that peak plate current,  $M_i$ , is conducted for peak instantaneous positive grid voltage

$$+e_c \cong E_b - ME_p$$

Then plate current will be conducted between instantaneous plate angles

$$\theta_p = \frac{\pi}{2} - \frac{B}{2}$$

$$\text{and } \theta_p = \frac{\pi}{2} + \frac{B}{2} \quad (4)$$

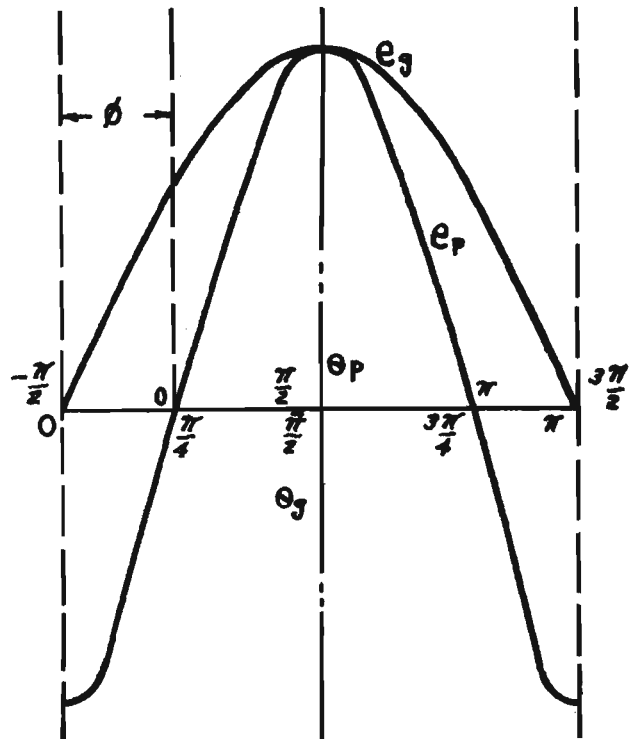

Figure 2. Grid Plate Alternating Voltage Relation in Doubler Amplifier.

In general the instantaneous value of plate load voltage at plate current cutoff is then

$$e_{p0} = ME_p \sin \left( \frac{\pi}{2} - \frac{B}{2} \right) \quad (5)$$

The plate voltage applied across the tube at cutoff is then

$$e_{b0} = E_b - ME_p \sin \left( \frac{\pi}{2} - \frac{B}{2} \right) \quad (6)$$

From the tube constant-current characteristics the instantaneous grid voltage,  $e_{g0}$ , corresponding to  $e_{b0}$  is found. The grid angle,  $\theta_{g0}$ , is from (3)

$$\theta_{g0} = \left[ \frac{1}{n} \left( \frac{\pi}{2} - \frac{B}{2} \right) + \frac{\pi}{2n} (n - 1) \right] \quad (7)$$

Since

$$\frac{E_c - e_{g0}}{ME_g} = \sin \theta_{g0} \quad (8)$$

and

$$ME_g = -(E_c - +e_c) \quad (9)$$

we get from (8) and (9) the required grid bias voltage

$$E_c = \frac{e_{g0} - +e_c \sin \theta_{g0}}{1 - \sin \theta_{g0}} \quad (10)$$



Next we obtain the plot of instantaneous plate and grid currents by selecting several points along the grid voltage or plate voltage axis alternating voltage intercepts. If points are taken at  $\theta_{pi}$ ,  $\theta_{pl}$ ,  $\theta_{pc}$ , etc., along the plate voltage axis, the corresponding grid angles  $\theta_{gi}$ ,  $\theta_{gl}$ ,  $\theta_{gc}$ , etc., along the grid axis are determined by (3). The location of these points along the axis is accomplished rapidly by means of a fully graduated sine scale similar to that described on page 27.

$$\frac{e_p}{ME_p} = \sin \theta_p \quad (11)$$

and

$$\frac{e_g}{ME_g} = \sin \theta_g \quad (12)$$

A curve is drawn through the intersection of lines projected from corresponding points perpendicular to their respective axes. The grid and plate current pulses may be plotted from points along this line.

From the curves of total instantaneous conducted plate and grid currents plotted as a function of the instan-

taneous fundamental frequency angle, the direct current and fundamental and harmonic alternating current amplitudes may be determined by harmonic analysis. Any of the several methods of harmonic analysis described in the literature may be used provided sufficiently accurate results are obtained. This latter point is particularly important in the case of frequency multiplier analysis since in general the conduction angles, especially the grid angles, are quite small and the wave forms irregular.

The calculation procedure may be considerably shortened by the determination of the current values requisite for the harmonic analysis directly from the constant current characteristic. This method will be followed here, and will be described in the second part of this article.

. . . .

#### References:

- 1 F. E. Terman, *Radio Engineering*, McGraw-Hill Co., 1937.
- 2 D. C. Prince, "Vacuum Tubes as Power Oscillators," *Proc. I. R. E.*, Vol. 11, June, August, October, 1923.
- 3 E. L. Chaffee, "The Operating Characteristics of Power Tubes," *J. App. Phys.*, Vol. 9, July, 1938.

# GRAPHICAL DESIGN OF FREQUENCY MULTIPLIER AMPLIFIERS

## PART TWO

### INTRODUCTION

IN the preceding chapter, a method of graphical analysis was described applicable to the exact design of frequency multiplier amplifiers. The underlying principles of operation were outlined and the choice of operating constants were discussed briefly. General expressions required in the analysis were developed and are referred to in this issue by number.

This chapter continues with the application of harmonic analysis to the problem, followed by an example of its use in the calculation of a typical design.

### HARMONIC ANALYSIS

In order to determine direct and alternating grid and plate current components it is convenient to apply Chaffee's<sup>1</sup> 13-point method of harmonic analysis directly to the curve drawn upon the constant current chart. The accuracy of this method of analysis is ample for the waveforms encountered in this application. Chaffee's<sup>1</sup> expressions for the required currents are:

$$I_{dc} = \frac{1}{24} \left[ i_1 + 2i_2 + 2i_3 + 2i_4 + 2i_5 + 2i_6 \right] \quad (13)$$

$$MI_1 = \frac{1}{12} \left[ i_1 + 1.93 i_2 + 1.73 i_3 + 1.41 i_4 + i_5 + .516 i_6 \right] \quad (14)$$

$$MI_2 = \frac{1}{12} \left[ i_1 + 1.73 i_2 + i_3 - i_5 - 1.73 i_6 \right] \quad (15)$$

$$MI_3 = \frac{1}{12} \left[ i_1 + 1.41 i_2 - 1.41 i_4 - 2i_5 - 1.41 i_6 \right] \quad (16)$$

$$MI_4 = \frac{1}{12} \left[ i_1 + i_2 - i_3 - 2i_4 - i_5 + i_6 \right] \quad (17)$$

In the above  $MI_1, MI_2, MI_3, MI_4$ , are respectively the amplitudes of the fundamental, second, third and fourth harmonic alternating current components of the analyzed current pulse in this case. The currents  $i_1, i_2, i_3$ , etc., correspond to grid angles  $\theta_{g1}, \theta_{g2}, \theta_{g3}$ , etc., spaced at 15 degree intervals along the axes as shown in Fig. 3. The points corresponding to these angles may be laid out quickly along the grid and plate axes by means of a sine scale.

It must be borne in mind, however, that points along the plate voltage scale are laid out at fundamental frequency angle separation. Thus we know that the intercept of the plate voltage amplitude on the plate voltage axis represents  $\frac{\pi}{2n}$  degrees of the fundamental frequency.

Accordingly the graduation  $\left( \frac{\pi}{2} - \frac{\pi}{2n} \right)$  on the

sine scale must be placed on the abscissa point corresponding to  $E_b$  as a base point. The points necessary to determine all required values of  $i$  may now be laid out.

The vertical projections of points corresponding to  $\theta_{g1}, \theta_{g2}$ , etc., shown as  $\theta_1, \theta_2$ , etc., in Fig. 3, along the plate axis upon the plotted curve determine plate currents  $i_{p1}, i_{p2}$ , etc., of expressions (13) to (17), from which  $I_b$  and  $MI_n = MI_p$  are obtained. From these values, harmonic power output,  $P_o$ , DC power input,  $P_i$ , plate dissipation,  $P_p$ , load resistance,  $R_L$ , and efficiency,  $n$  may be computed as follows

$$P_o = \frac{ME_p \times MI_p}{2}$$

$$P_i = E_b \times I_b$$

$$P_p = P_i - P_o$$

$$n = \frac{P_o}{P_i}$$

$$R_L = \frac{ME_p}{MI_p}$$

Points are laid out at 15 degree intervals along the grid voltage axis, knowing that the intercept of the alternating grid voltage amplitude,  $ME_g$ , corresponds to  $90^\circ$ . Horizontal projections of these points,  $\theta_{g1}, \theta_{g2}$ , etc., upon the plotted curve determine grid currents  $i_{g1}, i_{g2}$ , etc., of expressions (13) and (14), from which  $I_c$  and  $MI_1 = MI_g$  are obtained. From these values the grid drive power,  $P_g$ ,

# Federal Telephone and Radio Corporation

DC grid input power,  $P_g$ , and grid bias resistance,  $R_c$ , may be calculated as follows

$$P_g = \frac{ME_g \times MI_g}{2}$$

$$P_c = E_c \times I_c$$

$$R_c = \frac{E_c}{I_c}$$

not to be regarded as an optimum design. The graphical relations used in the computation are shown in Fig. 3.

We assume

- $E_b = 2000$  volts
- $ME_p = 1700$  volts
- $+e_c = 275$  volts
- $\beta = 210$  degrees

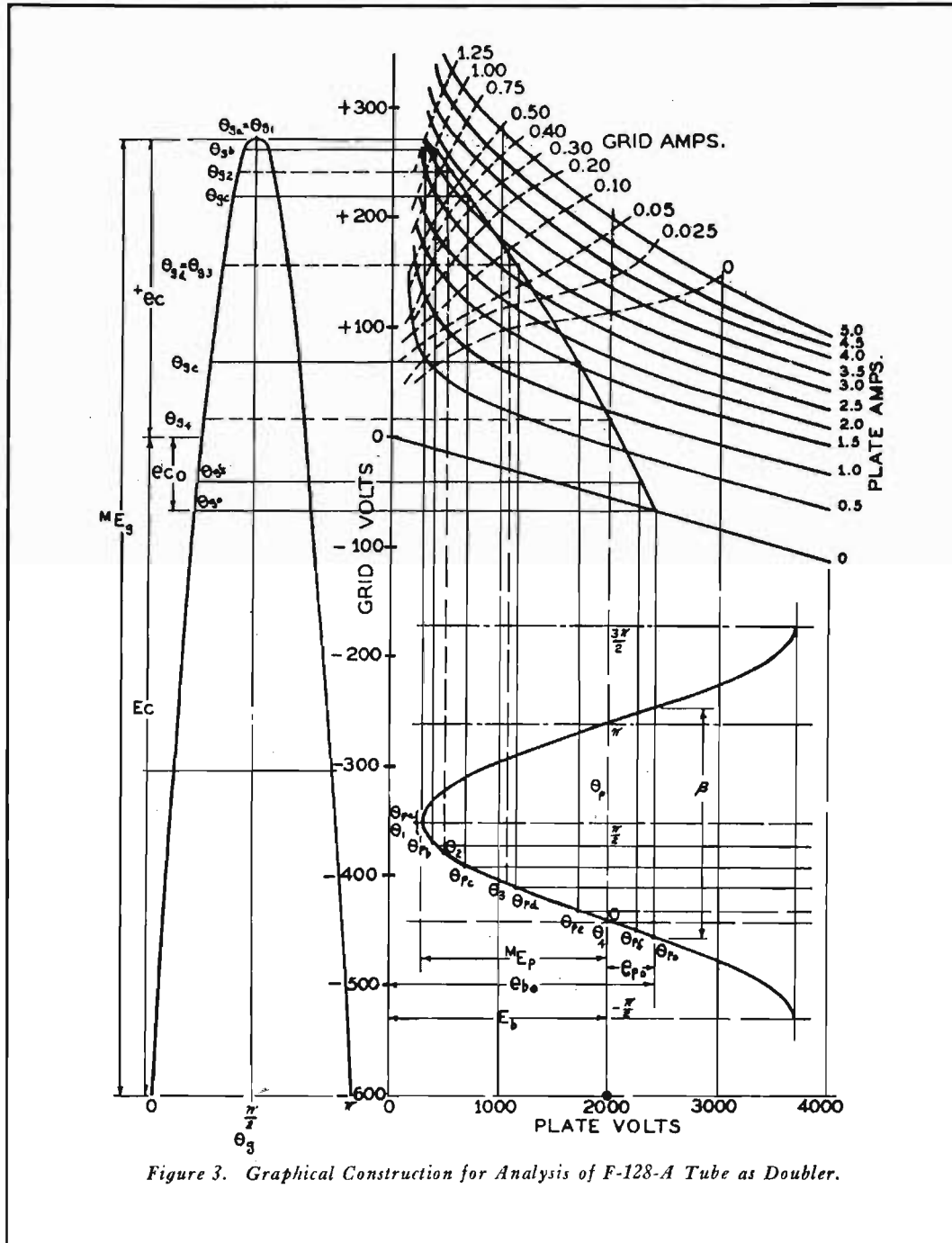

Figure 3. Graphical Construction for Analysis of F-128-A Tube as Doubler.

### EXAMPLE

We shall apply the above procedure to calculation of a Federal F-128-A tube used as a frequency doubler. The example is purely illustrative of the method and is

Thus from (4)

$$\theta_p = \frac{\pi}{2} - \frac{210}{2} = -15 \text{ degrees}$$

# HANDBOOK OF TUBE OPERATION

Plate load voltage at plate current cutoff point by (5)

$$e_{po} = 1700 \times \sin(-15) = -440 \text{ volts}$$

Thus from (6), the cutoff plate voltage,

$$e_{bo} = 2000 - (-440) = 2440 \text{ volts}$$

From the tube constant-current characteristics we find

$$e_{co} = -68 \text{ volts}$$

Using (7) we obtain

$$\theta_{go} = \left[ -\frac{15}{2} + 45 \right] = 37.5 \text{ degrees}$$

Then from (10), or graphically by means of sine scale we find.

$$E_c = \frac{-68 - 240 \sin 37.5}{1 - \sin 37.5} = -600 \text{ volts}$$

and from (9)

$$ME_g = 875 \text{ volts.}$$

To determine the locus of corresponding simultaneous grid and plate voltages, we lay out by means of the sine scale, an arbitrary number of grid voltage points,  $\theta_{ga}$ ,  $\theta_{gb}$ , etc., in this case proportional to 10 degree grid angle intervals. The corresponding plate angles,  $\theta_{pa}$ ,  $\theta_{pb}$ , etc., are found from (3) and located by the sine scale.

Applying harmonic analysis, locating the 15 degree interval points  $\theta_{g1}$ ,  $\theta_{g2}$ , etc., and  $\theta_{1}$ ,  $\theta_{2}$ , etc., by means of a sine scale as outlined in the procedure, we obtain instantaneous currents

$i_{b1}$	3.0 amperes	$i_{c1}$	1.25 amperes
$i_{b2}$	3.25 amperes	$i_{c2}$	.60 amperes
$i_{b3}$	2.75 amperes	$i_{c3}$	.08 amperes
$i_{b4}$	0.9 amperes	$i_{c4}$	0
$i_{b5}$	0	$i_{c5}$	0
$i_{b6}$	0	$i_{c6}$	0

Using the  $i_b$  values in (13) and (15) we compute,

$$I_b = \frac{1}{24} \left[ 3.0 + 2 \times 3.25 + 2 \times 2.75 + 2 \times 0.9 \right] = 0.70 \text{ amperes}$$

$$MI_p = \frac{1}{12} \left[ 3.0 + 1.73 \times 3.25 + 2.75 \right] = 0.95 \text{ amperes}$$

$$P_o = \frac{1700 \times 0.95}{2} = 807 \text{ watts}$$

$$P_1 = 2000 \times 0.70 = 1400 \text{ watts}$$

$$P_p = 1400 - 807 = 593 \text{ watts}$$

$$n = \frac{807}{1400} = 57.5 \text{ per cent}$$

$$R_L = \frac{1700}{0.95} = 1790 \text{ ohms}$$

Using the  $i_c$  values in (13) and (14) we get

$$I_c = \frac{1}{24} \left[ 1.25 + 2 \times 0.6 + 2 \times 0.08 \right] = 0.11 \text{ amperes}$$

$$MI_g = \frac{1}{12} \left[ 1.25 + 1.93 \times 0.6 + 1.73 \times 0.1 \right]$$

$$= 0.215 \text{ amperes}$$

$$P_g = \frac{875 \times 0.215}{2} = 95 \text{ watts}$$

$$P_c = 600 \times 0.11 = 66 \text{ watts}$$

$$R_c = \frac{600}{0.11} = 5500 \text{ ohms}$$

## OTHER APPLICATIONS

This graphical method may be applied as above to computation of multi-electrode and so called beam-power tubes operating as harmonic generators at fixed screen voltages.

It is apparent that the performance of a plate-modulated frequency multiplier may be determined also by using the above procedure to determine operating currents, etc., for points on the modulated plate supply voltage. In this case since the load impedance must be maintained constant over the modulation cycle, we must resort to a cut-and-try computation.

## GENERAL

The method of analysis given above shows that choice of relatively high amplification factor tubes is advantageous in harmonic amplifier design, since the negative grid bias necessary to obtain the required plate current conduction angle is less than for low- $\mu$  tubes. In general successful operation of frequency multipliers requires ample design of tubes to withstand the high grid voltage swings which must be applied to obtain optimum harmonic power output.

It is likewise apparent that when the maximum permissible grid bias is a limiting factor, operation at plate supply voltages considerably higher than that corresponding to the optimum plate current conduction angle is uneconomical.

In general, and particularly in this case, it is advantageous to drive the harmonic amplifier to high plate current peaks and low minimum instantaneous plate voltages. The grid must be capable of dissipating safely the high dissipation encountered under these conditions and hence liberal tube design is required for satisfactory operation and long life.

The amplitude of grid drive voltage applied to a frequency multiplier is seen to be quite critically dependent upon the operating conditions assumed. Thus, even if the grid is driven to so called "saturation", uniformity of tube characteristics is essential to facilitate interchangeability of tubes and to maintain uniform operating conditions.

### References:

1. E. L. Chaffee, "Simplified Harmonic Analysis," *Rev. Sci. Inst.*, Vol. 7, October, 1936; Vol. 8, June, 1937.

# GRID-BIAS MODULATED RF AMPLIFIERS

## INTRODUCTION

PREVIOUS chapters have presented methods of analysis of the Class B linear<sup>1</sup> and Class C plate-modulated<sup>2</sup> types of radio frequency power amplifiers which are most widely used in broadcast transmitters.

The general methods of radio frequency analysis<sup>3</sup> applicable to these amplifiers and methods of harmonic analysis<sup>4</sup> of their modulated output envelopes have also been treated in preceding articles.

The purpose of this chapter is to describe an exact method of analysis of the grid-bias modulated radio frequency amplifier.

While this amplifier has found wide application in the initial modulated stage of low level modulated transmitters, it has not been as widely used as other types for final stage power amplification. The limited use of this circuit in this application has been due to its inherently poor efficiency when low harmonic distortion of the modulated output is required.

Since the advent of degenerative feedback as a means of distortion reduction, it appears that grid-bias modulation might be used at appreciably higher carrier efficiencies while preserving satisfactory linearity.

In the conventional grid-bias modulated amplifier the grid-bias voltage is caused to vary at modulation frequency. Thus the RF grid excitation voltage which is impressed in series with the bias voltage is shifted correspondingly, causing a proportionate rise and fall of the RF plate current through the load.

A recent variation of grid-bias modulation methods is so-called cathode modulation. In this system the modulating voltage is applied in series with both the grid and plate circuits, thus varying both grid-bias and plate supply voltages at modulation frequency. The result is that the applied plate voltage is increased on positive modulation crests and decreased proportionately on negative crests. The permissible radio frequency carrier plate voltage amplitude may thus be increased above the normal grid-bias modulated value and a higher carrier-level output efficiency obtained.

In this issue graphical methods will be applied to the calculation of the conventional type of grid-modulated amplifier. A typical comparative design calculation is worked out.

## GENERAL CONSIDERATIONS

The grid-bias modulated amplifier is essentially a Class C RF power amplifier operated at a fixed unmodulated plate voltage. Radio frequency grid excitation voltage of fixed amplitude is applied. The grid-bias voltage is varied in accordance with the applied modulation, producing a corresponding variation of the fundamental RF component of the plate current through the fixed resonant-circuit load impedance.

As in all modulated RF amplifiers, in order to secure 100 per cent modulated linear operation, adjustment must be such that four times carrier power output is delivered on positive grid voltage crests, and the output falls to zero on negative crests. For linear operation the output current between these limiting points must be proportional to the grid voltage.

To satisfy crest conditions with the load impedance constant, the positive crest RF plate current amplitude

must be twice carrier value and the negative crest value must equal zero. Thus the RF plate voltage across the load impedance will also vary between these limits.

Considerations of maximum exploitation of the power capabilities of the tube require it to be operated at approximately cut-off grid bias under positive crest conditions. Thus the carrier-level grid-bias and audio frequency modulating voltage amplitude shall be so chosen as to vary the instantaneous bias from approximately cut-off value on positive crest to a value which will reduce the RF plate current to zero on negative crests.

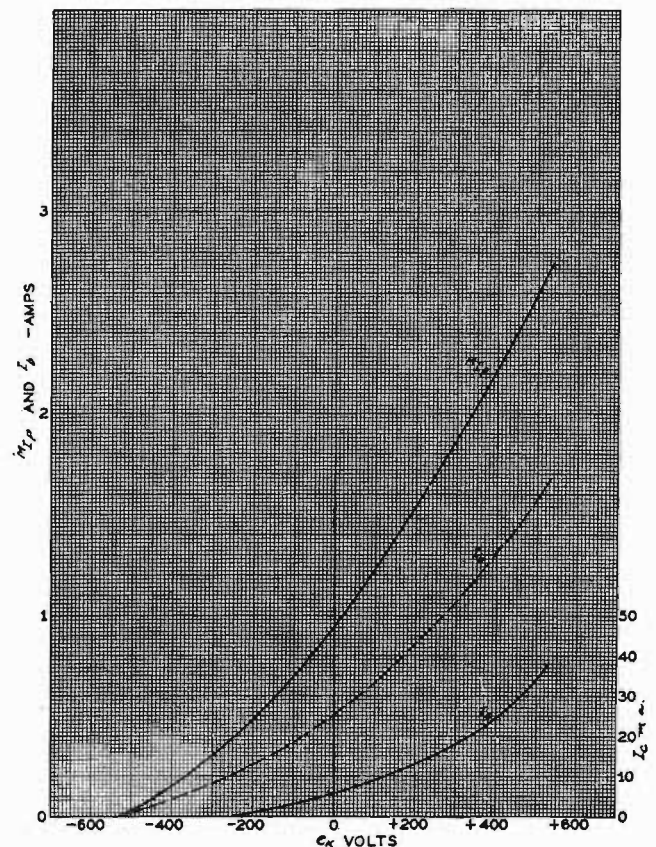

Fig. 1. Output Characteristics of F-343-A as Grid-Modulated Amplifier using Fixed Grid Bias.

The positive-crest RF voltage amplitude is limited by the considerations of linearity of tube characteristics and grid drive power available. For amplitudes such that the peak instantaneous plate and grid voltages are approximately equal, crowding of the tube characteristic is en-

countered causing the RF current to vary non-linearly with respect to the plate voltage. At this point the peak instantaneous grid current, and hence the RF and AF grid excitation power, become excessively high raising the average grid drive power required and, more important, make driving power sources of good regulation essential.

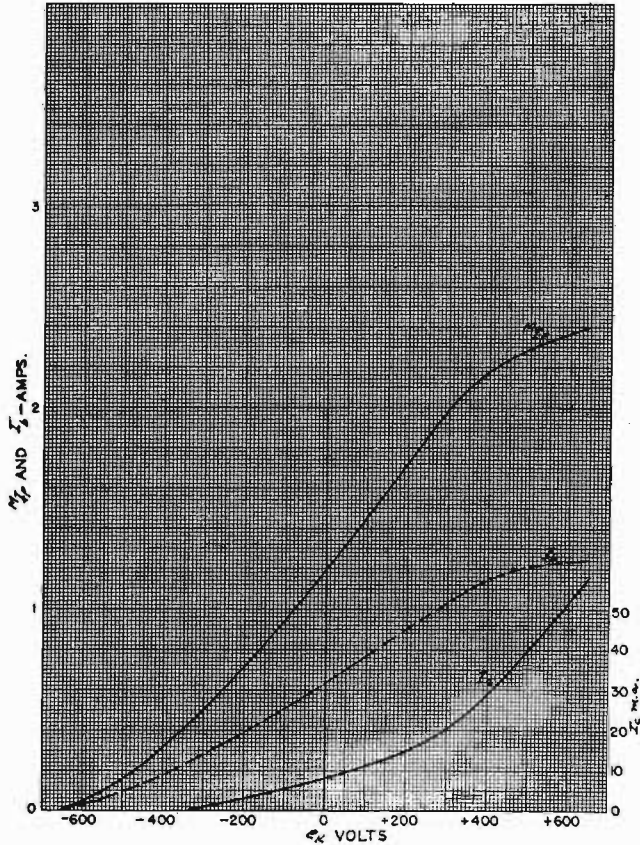

Fig. 2. Output Characteristics of F-343-A as Grid-Modulated Amplifier using Grid-Leak and Fixed Bias.

Poor grid drive regulation will cause a reduction in peak grid voltage on positive modulation crests with attendant amplitude distortion of the modulated output.

## GRAPHICAL ANALYSIS

Any one of the several practical graphical analytic methods may be used in the design of the grid modulated amplifier. Since cut-and-try computation must be resorted to in this case it is advantageous to adopt the most rapid method. For this reason Chaffee's 11-point harmonic analysis<sup>5</sup> of the radio frequency waveforms is used, while his 7-point method<sup>6</sup> is used for harmonic analysis of the audio frequency modulated envelope.

The 11-point analysis requires the location of instantaneous total RF plate current values  $i_b'$ ,  $i_b''$  and  $i_b'''$  corresponding respectively to instantaneous RF plate voltages  $e_p' = ME_p$ ;  $e_p'' = 0.866 ME_p$ , and  $e_p''' = 0.5 ME_p$ , where  $ME_p$  is the RF plate voltage peak amplitude. These points may be rapidly located by means of a correspondingly graduated sine scale<sup>7</sup> applied to the constant-current characteristics of the tube used. Total grid current values  $i_c'$ ,  $i_c''$  and  $i_c'''$  corresponding to the above plate voltage points are also obtained. The direct, ( $I_b$  and  $I_c$ ) and radio frequency ( $MI_p$  and  $MI_g$ ) current amplitudes are

determined from the instantaneous values by the following expressions:

$$I_b = \frac{1}{12} \left[ i_b' + 2i_b'' + 2i_b''' \right] \quad (1)$$

$$I_c = \frac{1}{12} \left[ i_c' + 2i_c'' + 2i_c''' \right] \quad (2)$$

$$MI_p = \frac{1}{6} \left[ i_b' + 0.707 i_b'' + i_b''' \right] \quad (3)$$

$$MI_g = \frac{1}{6} \left[ i_c' + 0.707 i_c'' + i_c''' \right] \quad (4)$$

The power output, plate power input, load impedance, efficiency, grid drive power and grid circuit constants may now be computed for any point on the modulation cycle.

The audio frequency harmonic content of the modulated output for a given percentage modulation is obtained by calculation of the RF plate current and other operating values for selected points of the modulation cycle. For Chaffee's 7-point method, calculations are made at instan-

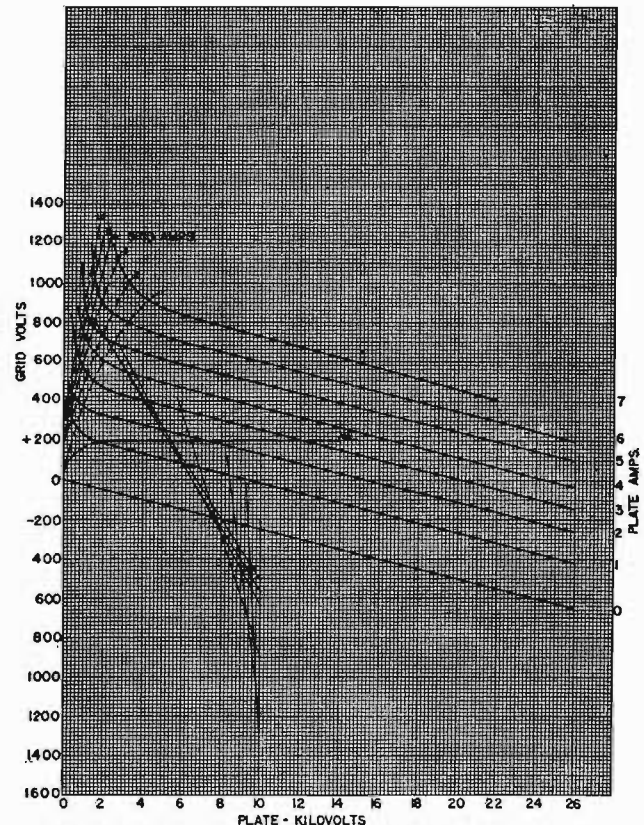

Fig. 3. Constant Current Characteristics of F-343-A showing Load Lines for Combination-Bias Operation.

taneous AF modulating voltages,  $e_k$ , equal to  $+ME_k$ ,  $+0.707 ME_k$ ,  $+0.5 ME_k$ ,  $0$ ,  $-0.5 ME_k$ ,  $-0.707 ME_k$  and  $-ME_k$  for the corresponding respective RF plate current amplitudes  $MI_p'$ ,  $MI_p''$ ,  $MI_p'''$ ,  $MI_p^0$ ,  $-MI_p'''$ ,  $-MI_p''$ , and  $-MI_p'$ . The above currents are all considered numeric-

ally positive, the negative sign designating current amplitudes in the negative half of the modulation cycle. The amplitudes of the fundamental,  $M_{I_p}$ , and harmonic,  $M_{I_{pn}}$ , (where  $n$  designates the order of the harmonic) components of the modulated output current envelope are given below. Here the numerical sum and difference of corresponding positive and negative half cycle amplitudes are indicated respectively, as:

$$S' = M_{I_p}' + (-M_{I_p}')$$

$$D' = M_{I_p}' - (-M_{I_p}'); \text{ etc.}$$

$$M_{I_{p1}} = \frac{S'}{4} + \frac{S''}{\sqrt{2}} \quad (5)$$

$$M_{I_{p2}} = \frac{5 D'}{24} + \frac{D''}{4} - \frac{D'''}{3} \quad (6)$$

$$M_{I_{p3}} = \frac{S'}{6} - \frac{S''}{3} \quad (7)$$

$$M_{I_{p4}} = \frac{D'}{8} - \frac{D''}{4} \quad (8)$$

$$M_{I_{p5}} = \frac{S'}{12} - \frac{2\sqrt{2} S''}{D''} + \frac{S'''}{3} \quad (9)$$

$$M_{I_{p6}} = \frac{D'}{24} - \frac{D''}{4} + \frac{D'''}{3} \quad (10)$$

For 100 per cent modulation, the calculated audio frequency components of the output are given in Table B.

The calculated data for the two cases is given in Table A, while Figs. 1 and 2 show the plotted output characteristics in the two cases:

## CONCLUSION

It is apparent from the above calculations that strict linearity of operation is not obtained for either the fixed or variable grid-bias modulated RF amplifiers above mentioned. However, considerably greater linearity and higher plate efficiency are indicated for the variable-bias amplifier.

	Fixed Bias	Combination Bias	
Second harmonic -----	16	1.8	per cent
Third harmonic -----	1.3	9.8	per cent
Fourth harmonic -----	1.5	1.5	per cent
Fifth harmonic -----	0.8	0.7	per cent
Sixth harmonic -----	0.8	2.5	per cent
Total RMS -----	16.2	10.5	per cent

TABLE B

With the use of inverse feedback compensation, the distortion for the latter type of operation may be reduced to a value making the use of this type of amplifier advantageous for broadcast applications.

	Fixed Bias		Combination Bias		
	Carrier	+ Crest	Carrier	+ Crest	
DC Plate Voltage, $E_b$ -----	10000	10000	10000	10000	volts
DC Grid Voltage, $E_c$ , fixed-----	-780	-780	-866	-866	volts
DC Grid Voltage, $E_c$ , leak-----	0	0	-34	-250	volts
Peak RF Grid Voltage, $ME_g$ -----	1060	1060	1310	1310	volts
Peak AF Grid Voltage, $ME_x$ -----	530	530	65.0	65.0	volts
Peak RF Plate Voltage, $ME_p$ -----	2800	8000	4250	8500	volts
DC Plate Current, $I_b$ -----	0.51	1.68	0.63	1.44	amperes
DC Grid Current, $I_c$ -----	0.006	0.038	0.014	0.058	amperes
RF Grid Drive Power, $P_g$ -----	-----	39	17	146	watts
AF Grid Modulating Power, $P_k$ -----	-----	10	-----	22	watts
RF Power Output, $P_o$ -----	1330	10900	2550	10200	watts
Plate Efficiency, $\eta$ -----	26	65	40	70	per cent
RF Load Impedance, $R_L$ -----	2950	2950	3600	3600	ohms

TABLE A

## APPLICATION

The above method of analysis has been applied to the design of a grid-modulated RF amplifier using the Federal F-343-A tube for illustration. In each case an output of approximately 10 kilowatts is obtained on 100 per cent modulation peaks. In the first case, however, fixed grid bias is used, while in the second case combination grid leak and fixed bias is applied.

### References:

1. April, 1939, issue of TUBES.
2. March, 1939, issue of TUBES.
3. September, 1938, issue of TUBES.
4. February, 1939, issue of TUBES.
5. J. App. Phys., Vol. 9, No. 7, July, 1938.
6. Rev. Sci. Inst., Vol. 7, No. 10, October, 1936 as corrected in July, 1937 issue.
7. March, 1939, issue of TUBES.

# FEDERAL DEVELOPS TUBE TO MEET WIDE SERVICE RANGE

## INTRODUCTION

**M**UCH has appeared concerning tube characteristics, ratings and the various factors entering into the selection of proper tubes for specific applications.

It may interest readers, therefore, to trace the development of a particular tube from its inception right through to completion and to learn something of the many factors which must be weighed in an effort to meet specific operating requirements.

## REQUIREMENTS OUTLINED

The Federal F-128 tube has been developed in response to a demand for an air cooled tube of approximately 600 watts plate dissipation rating, that would be capable of providing marked improvement in plate efficiency and power gain over existing types.

This tube had to cover a wide range of uses, all the way from low frequency marine service to high frequency point-to-point commercial service.

As a starting point, it was decided that the power gain should be at least 20-1 and the efficiency 75 per cent or higher, with both conditions readily obtainable at moderate plate voltages and over a frequency range of from 0.5 to 25 megacycles.

For marine service in particular, high performance should be obtainable with a maximum plate voltage of 3000 volts. At the same time, it was recognized as highly desirable that good performance should be obtained with a plate voltage as low as 1500 volts.

All the while it was understood that in order to cover these requirements adequately, certain characteristics would be essential which at the same time would be beneficial to the application of the tube to radio telephone service.

## USING KNOWN FACTORS AS BASIS

It is well known that in the case of any given tube, the possible plate efficiency increases as the drive and plate voltages are increased, whereas the driving power for a given output decreases as the plate voltage is raised. In order to obtain high efficiency, high output and low drive power at low plate voltages, however, it is necessary to have a tube of high mutual conductance.

Occasionally, driving power can be reduced considerably by the introduction of sufficient secondary emission, as was explained in an earlier chapter. This method has definite limitations, however, in that too much secondary emission tends to cause instability. Hence, it is much more preferable to obtain low drive by providing high mutual conductance rather than to depend upon secondary emission to accomplish this purpose.

A glance at the conventional family of plate curves published for most transmitting tubes will disclose a

line near the plate voltage zero axis marked  $E_g = E_p$ . This line is commonly referred to as the composite diode line and is most often used as the limit of plate voltage and current swings on any load line. Excepting when used as a doubler or as in other cases where high harmonic output is required, there is little need of swinging to the left of the diode line.

The power output is the product of the AC components of plate voltage and plate current, multiplied by a factor dependent in turn upon the angle of plate current flow. These components are obtained by projecting from the end of the load line on the composite diode line to the voltage and current scales. Obviously, the more steeply the diode line rises, therefore, the greater will be these AC components and the greater will be the output and efficiency. The steeper this line is, the lower will be the impedance of the tube and the easier will it be to deliver power into a low impedance load.

## DESIGN FACTORS

It follows that certain design considerations are necessary to provide a steep diode line or high mutual conductance. The most important of these is inter-electrode spacing.

In general, it may be said that the larger the electrodes and the smaller the spacing, the higher will be the mutual conductance. At the same time, larger electrodes and smaller spacing lead to higher inter-electrode capacitances, notwithstanding these must be held within reasonable limits if the tube is to be applicable to high frequency service. At the same time also, it is necessary to bear in mind that as the spacings grow smaller, there follows a decided tendency toward absence of uniformity and lack of interchangeability among tubes themselves.

In order to meet all of these requirements, there remained only one alternative and that was to attempt a number of compromises.

Starting with plate dissipation as the first requirement, it was recognized that an anode of certain minimum dimensions would be needed to provide sufficient radiating surface.

It was decided, therefore, to use the "plane electrode" or rectangular cross section of grid and plate type of construction because, for a given size of anode, the effective



spacings may be considerably less than for cylindrical structures of reasonable filament dimensions. Consequently, the mutual conductance would be higher with the "plane electrode" type of construction.

Much has been said of late concerning the "perveance" of a tube. This is merely a term which defines the ability of a tube to pass plate current and is entirely dependent upon the geometry of the electrodes as illustrated in its formula

$$G = K \frac{A}{X_a X_g}$$

- G = Perveance
- K = A constant (for the tube structure)
- A = Effective anode area
- X<sub>a</sub> = Effective anode radius
- X<sub>g</sub> = Effective grid radius

is to reduce the spacing between the grid or anode and the filament. Both methods, however, lead toward increased G-P capacitance and critical spacings.

The solution of the problem lies in the fact that the effective values control the capacitances, hence by making the entire anode effective, it is possible to reduce the X<sub>g</sub> factor and still retain a high G. This is what has been done in the case of the Federal F-128 tube.

The grid-filament spacing has a certain practical minimum other than the point where there is danger of short circuit. As an example, if the spacing between these two elements is too small, it becomes so critical that extremely small variations in dimensions will result in large variations in characteristics. Here again in the design of the Federal F-128, those grid dimensions were determined upon, which would provide an effective compromise between these two factors.

**AVERAGE PLATE CHARACTERISTICS F-128-A Transmitting Tube**

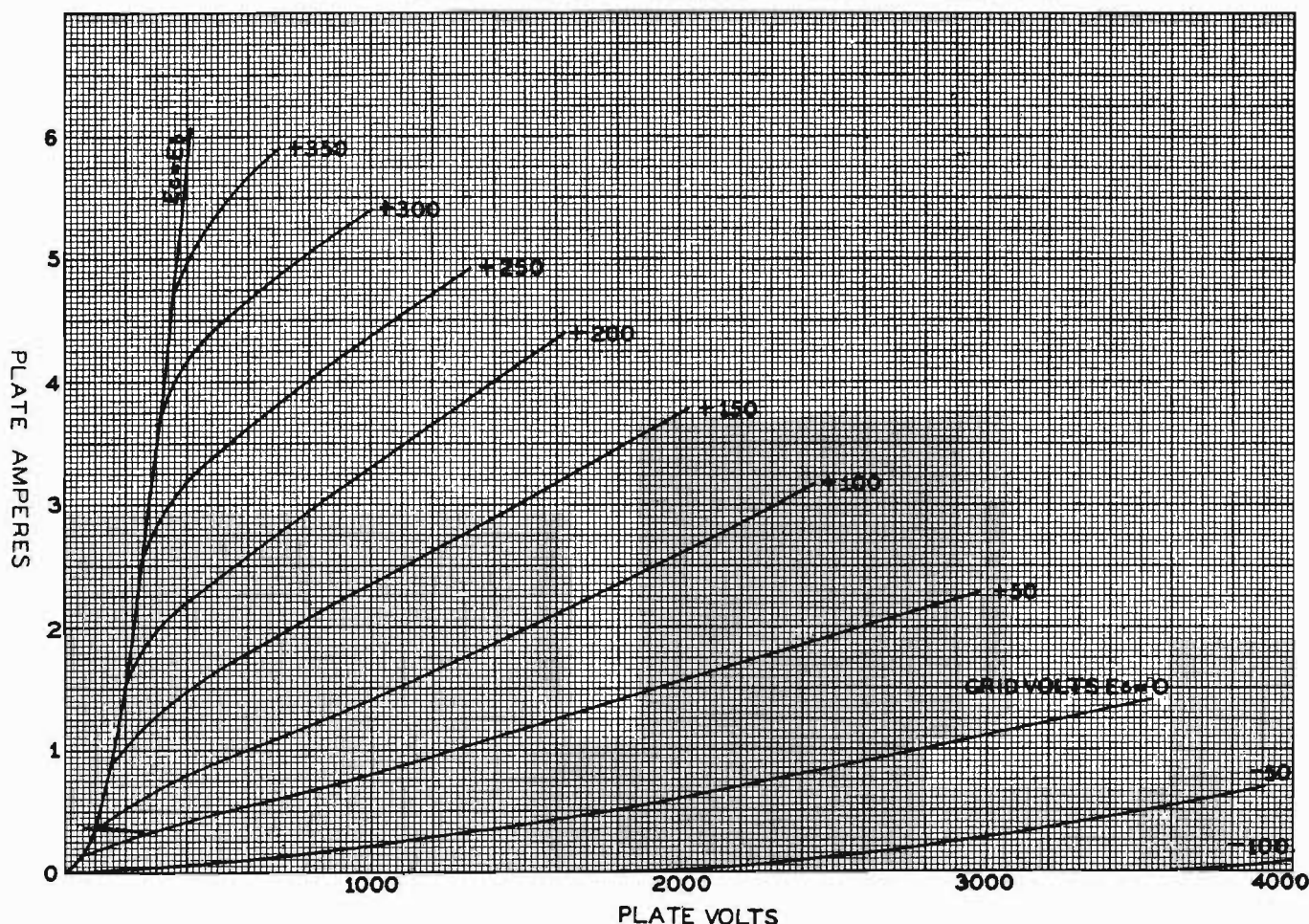

Insofar as the user of the tube is concerned, a high perveance means a steep diode line and a low perveance means a line with less slope. While quantitative determinations of the perveance are not easy to make from the published characteristic curves, a comparison may readily be made from the diode line in the plate family.

It is apparent from the formula just given that the perveance may be increased by either one of two methods. One is to increase the effective anode area. The other

### TYPES OF MATERIALS CAREFULLY CHOSEN

Federal F-128 has a graphite anode. This was chosen for several very good reasons.

First of all, the graphite surface approaches very closely perfect black body radiation. In consequence, it will operate at lower temperature per unit area per watt plate dissipation. The lower temperature naturally reduces the tendency of other parts of the tube to warp, which

# HANDBOOK OF TUBE OPERATION

---

would result from excessive heat. More important still, however, is that it reduces the heat reflected back to the filament.

If the heat reflected back to the filament were allowed to become appreciable, the result might be to raise the temperature of the filament above the optimum range when the anode is running at full rated dissipation. On the other hand, if allowance were made for the increased heat, the filament would be too cold when conditions of operation do not require full dissipation.

Furthermore, the possibility of anode warpage is eliminated when carbon is used and at the same time, it is possible to hold the dimensions to very close tolerances. In this case, it has been possible to take advantage of these several virtues attributable to carbon, since excessive plate dissipation and plate voltages were not among the design requirements.

## TYPE OF CONSTRUCTION CAREFULLY WEIGHED

The grid is of the rectangular cross-section type, with

the lateral wires notched and swedged into the vertical support wires. One advantage of the flat or rectangular cross-section grid is that it usually requires only two support wires, which may be positioned so as to effect a minimum of distortion upon the field of the grid.

The thoriated tungsten filament used in the Federal F-128 has been designed primarily to provide an adequate reserve of emission. Inasmuch as filament power consumption is usually considered of comparatively little importance, no special efforts have been made to hold it down to a minimum.

In this filament, a total emission of twelve amperes is provided, thus allowing an available emission of six amperes.

Examination of the plate family will show that there is no tendency on the part of the curves to crowd together at the high positive grid voltages. This characteristic is of great importance in classes of service where linearity is required and is obtained by providing adequate emission.

# ESSENTIAL ELEMENTS IN TRANSMITTING TUBES

## INTRODUCTION

**M**ORE than twenty different materials are used in the manufacture of the average transmitting tube. They are gathered from all over the world.

Some of them are rare and difficult to obtain. Others can be obtained in the desired quality only from certain localities in remote regions, thereby strictly limiting the source of supply.

### IMPORTANCE OF HIGH QUALITY

Purity of materials ranks first in importance in the successful manufacture of transmitting tubes. It is the invisible element that determines whether tubes will stand up to expectations. Hence, it is more important even than manufacturing skill, notwithstanding that workmanship of the highest order obtainable is absolutely essential in every operation. In other words, the precision required does not permit of any shortcuts, but skill means little in the manufacture of tubes if materials of the necessary quality are lacking.

For obvious reasons, it is not enough simply to buy materials from carefully selected sources. It will not do even to rely solely upon means for rigid inspection and elaborate tests of these materials when they arrive at the factory to make certain that they meet all specifications. Throughout manufacture, every known means must be exercised to prevent contamination. As an example, various elements after being properly treated and made ready for assembly must be kept under constant vacuum day and night until required for use.

Frequent tests between operations during the course of manufacture very often disclose impurities not previously distinguishable. Consequently, cleanliness throughout the tube manufacturing plant becomes an obsession. Operators who come into contact with the various elements wear freshly laundered white gloves, because contamination and its consequent difficulties have more than once been traced to nothing more than a fingerprint.

### RESULTS OF IMPURITIES

As is generally known, responsibility for a substantial share of the difficulties encountered with tubes during operation is traced to the presence of undesirable gas. Distinction must, of course, be made here between high vacuum tubes and those depending upon a specific gas to provide certain operating characteristics.

In high vacuum tubes where an attempt is made to remove each and every molecule of residual gas the slightest trace of oxygen, water vapor, nitrogen, metallic vapors or similar gases will have undesirable and sometimes damaging effects upon tubes and their operation.

Obviously, purity of materials used in the manufacture of tubes is largely a matter of degree. In some materials, 99.99 per cent is not always sufficient to insure satisfactory tube operation. Hence, we see the need of a full time chemist thoroughly familiar with materials used,

together with the sources, components and inherent characteristics of these materials.

Since a complete review of the various operations relating to the maintenance of a high degree of purity in all of the various elements would require many pages, this series will be devoted to the better known materials. Possibly it will contain also an element of surprise for those who have not visited a tube manufacturing plant and witnessed the various operations.

### COPPER

Copper offers an interesting illustration. It is commonly recognized in every water cooled tube and as every engineer is aware, copper to be employed successfully in transmitting tubes must of necessity be what is known as oxygen free copper. As every engineer also knows, copper has a low melting point when compared with other metals. That is the reason, of course, why the anode of a transmitting tube must be artificially cooled.

Frequently the question is asked whether the same extreme care is necessary in selecting copper for tube manufacture as applies in the case of some of the lesser known metals. The answer is decidedly in the affirmative. This is manifested not only in the results obtained during manufacture, but as well in operation and life expectancy of the tube while in the transmitter.

One reason lies in the fact that truly oxygen free copper lends itself much more readily to a satisfactory metal to glass seal. Obviously, without such a seal the necessary high vacuum within the tube could not be maintained.

When copper is first received at the plant, it undergoes a series of microscopic, physical and chemical tests. This determines the extent to which oxygen has been removed from the metal and detects oxygen which may have been trapped in the copper at the rolling mill. Tests for the same purpose are then repeated at intervals throughout manufacture to make certain that none has found its way in during handling or processing.

There are other factors of equal importance. Occluded impurities would of course give off gas. The property of oxygen free copper of being easily drawn and formed into intricate shapes without damage to its grain structure is a decided advantage in manufacture.

Comparison of copper with tungsten and other materials offers some very interesting contrasts and shall be covered at a later date.

## TUNGSTEN OFFERS CONTRAST

Tungsten differs from copper in one outstanding respect. While copper has a very low melting point, tungsten has the highest melting point definitely known.

There are, of course, other differences. Contrary to most metals, metallic tungsten is not formed by a smelting or electrolytic process. Tungsten oxide is obtained from tungsten bearing minerals. This is then reduced to metallic tungsten in the form of finely divided particles.

Tungsten ingots are formed by subjecting the finely divided tungsten first to high pressures and a very high temperature. After that it is swaged, hammered or drawn to the desired size.

As will be seen, if impurities exist in the original tungsten oxide they are given no opportunity whatever to escape. More than that, it is safe to say that they are literally hammered in to stay.

It can be seen further, that because of this process the final metallic tungsten does not have the characteristic structure of a metal which has been melted and solidified. On the contrary, constant hammering instead often results in cracks and splits not always visible on the surface and which render tungsten useless for tube construction. Hence, such material must be detected and rejected since it would otherwise result in costly defects.

Tungsten is used in transmitting tubes for filaments and for electrical connections through the glass envelope. It is used for filaments because of the extremely high melting point mentioned earlier and because it is the most satisfactory material found to date which will withstand the severe service necessary in high power transmitting tubes. In the case of filament leads, it is the most practical metal for sealing to glass because its temperature coefficient of expansion approaches very closely that of the type of glass used in such tubes.

The presence of impurities in tungsten used in transmitting tubes just as that in copper may result in the formation of gas, the destruction of the sealing characteristic or both. Probably most annoying in the selection of fit material for tube manufacture, however, is the frequency with which tungsten is found to have splits or cracks not visible to the naked eye. As already mentioned, this requires extreme care in inspection. Unless each and every one of these minute imperfections is detected microscopically before being used in the tube, it becomes obvious that a vacuum tight seal is not possible.

## MERCURY HEAVY METAL

Insofar as metals are concerned, at the other end of the temperature scale from tungsten is mercury. Mercury has the lowest boiling point of all. This is one of the heaviest metals known and as everyone has observed is liquid at room temperature.

It is used not only in transmitting tubes, but in condensation pumps which make it possible in the manufacture of these tubes to attain the very high degree of vacuum for the proper operation of these tubes.

Because it amalgamates readily with several other metals, it is difficult to obtain mercury sufficiently pure for these uses.

Mercury sufficiently pure for tube manufacture is not obtainable commercially. Gas and other harmful effects upon the tube elements would result from sublimation of impurities if commercial mercury was used. Only by further purification processes in the tube manufacturing plant is it possible to obtain mercury of such purity as to guarantee satisfactory life and operating characteristics to the tube in which it is used.

These processes include passing the mercury in a finely divided stream in turn through several different chemical solutions, each of which removes even minute traces of given impurities.

Following this treatment, the mercury is given a number of separate distillations to further insure the separation of any remaining extraneous matter. Even after this rigid treatment, a spectroscopic analysis is made in order to remove all question of absolute purity.

## MANY MATERIALS INVOLVED

The materials mentioned thus far in this series obviously represent a very small percentage of the important materials used in the manufacture of transmitting tubes.

To name just a few others among metals there are, nickel, molybdenum and tantalum. Among the chemical compounds are carbonates used for producing chloric and hydrofluoric acids.

Consider that these represent only a portion of all the materials used in the manufacture of transmitting tubes and then consider the fact that the manufacturing process throughout must be so controlled as to prevent the slightest contamination which would undo the benefits already gained and the size of the task may be imagined.

# TECHNICAL TUBE DATA AND WHAT IT MEANS

## INTRODUCTION

FOR some time, it has been felt that a primer devoted to the interpretation of terms most commonly found in published data on tubes would serve a very useful purpose.

For obvious reasons, the explanations contained herein are in no sense definitions. Much time has been expended in committee by various organizations for the purpose of defining terms to be used in literature devoted to radio. For those seeking precise definitions, attention is directed to the "Standards On Electronics," published by the I. R. E.

For the reader desiring a convenient and compact list of explanations confined wholly to the terms found in the average tube data sheet and intended primarily to assist in making clear the intent of the various terms used, it is hoped that this chapter will take the form of a handy reference.

### FILAMENT VOLTAGE

The filament voltage given is the voltage to be applied at the terminals of the tube.

In the case of tubes having bright tungsten filaments, the value given represents the maximum. If satisfactory operation can be obtained, a lower value may be used with increased filament life.

In the case of thoriated tungsten, or oxide coated filaments, the filament voltage should be maintained as closely as possible to the figure given.

### THERMIONIC EMISSION

The thermionic emission value given represents the total space current that can be drawn from the filament at rated filament voltage.

This would represent the sum of the peak grid and plate currents. When a filament is operated at saturation the peak grid and plate currents reach the total emission value.

### AVAILABLE THERMIONIC EMISSION

Because operation of thoriated filaments at saturation tends to deplete the emission rapidly it is advisable to limit the peak space current to some value lower than the total emissive capability. Hence, a figure of available thermionic emission is given.

This figure makes allowance for the above effect and in addition takes care of the variation present in the emission of thoriated filaments.

### AVERAGE CHARACTERISTICS

If all tube characteristic curves were straight lines the characteristics would be the same no matter where they were taken. Since they are not, characteristics are meaningless unless the point at which they are taken is given.

This point is usually selected as a point which gives results that are representative of the performance under usual operating conditions.

### AMPLIFICATION FACTOR

The amplification factor or  $\mu$  is the plate voltage change required to give the same plate current change as a unit change in grid voltage.

This would give the actual voltage amplification of the tube if operated into a load of infinite impedance.

### PLATE RESISTANCE

The plate resistance is the change in plate voltage required for a unit change of plate current with the grid voltage constant.

### MUTUAL CONDUCTANCE

The mutual or transconductance is the change in plate current for a unit change in grid voltage with the plate voltage constant.

At any given point these three characteristics are inter-dependent according to the following relationships:

$$\frac{\mu}{G_m} = R_p; \quad \frac{\mu}{R_p} = G_m; \quad G_m \times R_p = \mu$$

TECHNICAL DATA	
Main Use	R-F Power Amplifier Oscillator Class B Modulator
Number of Electrodes	3
Filament Voltage Per Strand	13.6 volts
Current Per Strand	68.5 amperes
Type	Multistrand Tungsten
Excitation	D-C, 1, 3, or 6 $\Phi$ A-C
Thermionic Emission	35 amperes
Average Characteristic Values calculated at $E_b = 8000$ , $I_b = 1.6$ amperes, $E_f = 13.6$ volts per strand	
Grid Voltage (approximate)	0 volts
Amplification Factor	42
Mutual Conductance	14000 micromhos
Plate Resistance	3000 ohms
Approximate Direct Inter-electrode Capacitances	
Plate to Grid	29 mmf.
Grid to Filament	37 mmf.
Plate to Filament	5 mmf.
Overall Dimensions	
Maximum Length	25 15/16 inches
Maximum Radius	6 1/4 inches
Type of Cooling	Water
Water Jacket	Standard or Federal Type 1010-C

Fig. 1. An illustration of typical technical data, in this case covering Federal type F-124-A.

# HANDBOOK OF TUBE OPERATION

## DIRECT INTERELECTRODE CAPACITANCES

Direct capacitances are the capacitances measured between the two electrodes in question with the remaining electrodes grounded and the filament cold.

Obviously, the effective capacitances in a circuit would differ from these values depending upon the other circuit constants.

## MAXIMUM RATINGS

Maximum ratings are those within which all tubes of a given type should give satisfactory operation and long useful life.

Since the actual limiting factors are not readily observed by the user of the tube, the ratings are translated into values that are usually known or can be readily measured.

Each rating is independent of the others, that is, operation should be arranged so that none is exceeded even though the other conditions may be far below the maximum.

Since the relationship between the actual limiting factors and the observable conditions varies with the class of operation, a set of maximum ratings is provided for each class for which the tube in question is suitable.

## TYPICAL OPERATION DATA

Typical operation data is usually given for classes of operation commonly used with a given type of tube.

<b>MAXIMUM RATINGS</b>	
<b>F-124-A Transmitting Tube</b>	
For maximum frequency of 20 megacycles	
<b>CLASS B AUDIO AMPLIFIER OR MODULATOR</b>	
D-C Plate Voltage	20000 volts
Max. Signal D-C Plate Cur.	5.0 amperes
Max. Signal Plate Input	50000 watts
Plate Dissipation	30000 watts
<b>CLASS B R-F POWER AMPLIFIER TELEPHONY</b>	
(Carrier conditions per tube for use with modulation factor up to 1.0)	
D-C Plate Voltage	20000 volts
D-C Plate Current	3.5 amperes
R-F Grid Current	50 amperes
Plate Input	60000 watts
Plate Dissipation	40000 watts
<b>CLASS C R-F POWER AMPLIFIER—TELEPHONY—PLATE MODULATED</b>	
(Carrier conditions per tube for use with modulation factor up to 1.0)	
D-C Plate Voltage	14000 volts
D-C Plate Current	4.5 amperes
D-C Grid Current	2.0 amperes
R-F Grid Current	50 amperes
Plate Input	60000 watts
Plate Dissipation	30000 watts
<b>CLASS C R-F POWER AMPLIFIER AND OSCILLATOR TELEGRAPHY</b>	
(Key-down conditions per tube without modulation)*	
D-C Plate Voltage	20000 volts
D-C Grid Voltage	-3000 volts
D-C Plate Current	7.0 amperes
D-C Grid Current	2.0 amperes
R-F Grid Current	50 amperes
Plate Input	135000 watts
Plate Dissipation	40000 watts

\*Modulation essentially negative, may be used if the positive peak of the audio frequency envelope does not exceed 115% of the carrier condition value.

Fig. 2. Maximum ratings usually appear in the form above.

<b>TYPICAL OPERATING DATA</b>	
<b>F-124-A Transmitting Tube</b>	
<b>CLASS C, R-F POWER AMPLIFIER AND OSCILLATOR-PLATE MODULATED</b>	
(Carrier conditions per tube for use with a modulation factor up to 1.0)	
Filament Voltage	13.6 volts per strand
D-C Plate Voltage	12000 volts
D-C Grid Voltage	-725 volts (approx.)
Peak R-F Grid Input Voltage	1425 volts (approx.)
D-C Plate Current	3.31 amperes
D-C Grid Current	0.061 amperes
Driving Power	87 watts (approx.)
Power Output	26200 watts (approx.)
<b>CLASS B, R-F POWER AMPLIFIER</b>	
(Carrier conditions per tube for use with a modulation factor up to 1.0)	
Filament Voltage	13.6 volts per strand
D-C Plate Voltage	17500 volts
D-C Grid Voltage	-300 volts (approx.)
Peak R-F Grid Input Voltage	480 volts (approx.)
D-C Plate Current	2.1 amperes
D-C Grid Current	-0.02 ampere
Driving Power*	100 watts (approx.)
Load Impedance	2550 ohms
Power Output	13100 watts (approx.)
* At crest of A-F cycle.	

Fig. 3. Typical Operating Data.

These do not necessarily represent the optimum conditions of operation for any particular case.

These tables are included in published tube information to serve as a guide in the selection of tubes for design purposes.

## DC PLATE VOLTAGE

The DC plate voltage is the plate voltage as read on a DC meter at the tube.

It is necessary to allow for any drop that may exist between the rectifier and the tube.

## DC PLATE CURRENT

The DC plate current is the average value of plate current as read on a DC meter in the plate circuit.

Unless otherwise specified the value given is for the carrier conditions, that is with drive on but no modulation.

## MAXIMUM SIGNAL DC PLATE CURRENT

The maximum signal DC plate current is the average value of plate current with a sine wave signal on the grid of value sufficient to provide the specified output.

This term is usually applied only to Class B or AB audio operation.

## ZERO SIGNAL DC PLATE CURRENT

The zero signal plate current is the steady value of plate current with no alternating voltage on the grid of the tube.

## PLATE INPUT

The plate input is the product of the DC plate voltage and DC plate current.

## MAXIMUM SIGNAL PLATE INPUT

The maximum signal plate input is the product of the DC plate voltage and the maximum signal DC plate current.

## **DC GRID VOLTAGE**

The DC grid voltage is the DC voltage, usually negative, used to bias the grid of the tube. This may be obtained from a separate voltage source or from the drop across a grid or cathode resistor.

## **R. F. GRID CURRENT**

The R. F. grid current is the R.M.S. value of the current through the grid terminal such as would be measured with a thermal ammeter.

## **DC GRID CURRENT**

The DC grid current is the average value of current in the grid circuit as read by a DC meter.

In Class A applications where the grid is never positive with respect to the filament there may be a low value of current flowing in such a direction that it would read on a meter with the positive terminal connected to the grid and the negative terminal connected to the cathode. This current is usually called reverse grid current.

## **PLATE DISSIPATION**

The plate dissipation is the difference between the plate input and the tube output (obtained from adding the circuit loss to the net output).

In the case of water cooled tubes, a fairly accurate measurement of plate dissipation can be made by measuring the water flow and temperature rise, making allow-

ance for the grid and filament dissipation, 100 per cent of which may be assumed to be dissipated at the anode.

## **LOAD IMPEDANCE**

The load impedance is the impedance presented to the plate of the tube. In all cases of calculated operating conditions the load is assumed to be purely resistive.

## **POWER OUTPUT**

The power output is the product of the AC components of plate voltage and plate current.

This figure is always somewhat higher than the measured value of power output because of circuit losses.

## **DRIVING POWER**

The driving power is the average power dissipated in the grid of the tube and the biasing device.

In some cases this figure is much lower than the power capability of the driving stage. The discrepancy may be the result of either the high peak power required in relation to the average or of the necessity to provide a high voltage swing.

## **PEAK R. F. GRID INPUT VOLTAGE**

The peak R. F. grid input voltage or grid voltage swing is the peak value of the AC grid voltage measured from the bias point.

This value is sometimes called the grid voltage swing.

# CARE AND OPERATION OF MERCURY VAPOR RECTIFIER TUBES

## INTRODUCTION

ONCE properly installed, little attention is normally paid to the power supply of a radio transmitter. While it supplies the basic energy required to operate the equipment, it does not call for constant surveillance.

It is recognized nevertheless, that by the exercise of reasonable care and by following a few simple rules, certain difficulties can be avoided and longer life obtained.

## MERCURY VAPOR TUBES

Since most power supplies today consist of rectifiers using mercury vapor tubes, the proper care of these tubes is of first importance. In any event, these tubes require periodic replacement and if as a result of proper treatment this replacement can be postponed along with highly efficient operation throughout normal life, this becomes highly desirable.

The suggestions which follow, therefore, are intended to convey a clear understanding of the operation and care of mercury vapor tubes required to obtain optimum results.

## INSTALLATION

A mercury vapor tube should always be mounted in a vertical position with the filament connections down. In this position, no filament sag will be experienced nor will metallic mercury be deposited on the active elements of the tube.

The mounting should be so arranged as to prevent mechanical shocks or vibrations from being transmitted to the tube. This prevents elements from shifting, seals from being strained, and the cathode coating from becoming loose. Any one of these conditions would reduce the life of the tube.

Mercury vapor tubes are designed to operate between certain definite limits of ambient temperature. This temperature should be measured in the tube compartment at a point opposite the filament base of the tube and approximately one foot away.

If this temperature exceeds the maximum for the particular type of tube, forced air cooling should be used. For obvious reasons, the temperature of this should be measured in the air stream before it reaches the tube. If the ambient temperature is below the minimum limit for satisfactory operation, heaters should be installed to raise it to a point within the safe operating range.

Since most rectifiers employ more than one tube and as in the case of most equipment of this type space is at a premium, it is necessary to place the tubes quite close together. If too little space is left between them, heat radiation from one may be absorbed by the other, raising the mercury temperature to a point beyond the safe limit even though the ambient temperature is within the specified range. A safe minimum distance between tubes is six inches and if possible, a still greater distance should be allowed for the larger tubes.

## TEMPERATURE CONTROL

In the lower curve shown in the accompanying illustration, it is seen that the space charge is dependent upon the temperature of the mercury vapor in such a manner that the space charge increases as the temperature decreases. The heavy and comparatively immobile positively charged mercury vapor ions normally do not contribute to the space current. If the vapor temperature becomes so low, however, that the space charge exceeds what is considered a critical value of approximately 22 volts, the ions acquire sufficient velocity in the direction of the cathode to result in damaging bombardment to the oxide coated cathode. This situation corresponds to a mercury vapor temperature somewhat less than 15° C.

If, on the other hand, the mercury vapor temperature is increased to avoid cathode disintegration, the effect of such increased temperature on the so-called "arc-back" voltage must be considered. An arc-back is caused by the inverse voltage to which the tube is subjected during the non-conducting portion of the cycle.

The upper curve in the illustration shows qualitatively the relation between mercury vapor temperature and the arc-back voltage. This curve shows that as the temperature is increased beyond a point designated as the maximum allowable temperature, the arc-back voltage decreases very rapidly.

These curves do not have particular values of temperature or voltages noted since they are intended to apply generally to all sizes of mercury vapor tubes. The limiting conditions, however, can be taken from the published data for any particular type of tube.

Mercury vapor tubes when used to furnish power to a radio frequency transmitter should be shielded from the radio frequency field. This field may be produced by direct radiation or by conduction back through the leads. Ionization of the mercury vapor by the radio frequency field may have an undesirable effect upon the cathode, but more important is its effect in reducing the value of inverse voltage that the tube will withstand.

Mercury vapor tubes should not be mounted so that the glass is in contact with metal nor should the glass be subjected to any spray or to drops of liquid of any kind. This localized cooling of the glass may develop strains which will ultimately crack the bulb and cause failure of the tube.



## TUBE PROTECTION

The mercury vapor rectifier is essentially a high speed switching device which in its simplest form provides a closed circuit to forward current and an open circuit to inverse current. It differs from the high vacuum device in that there is no throttling action or in other words the voltage drop across the tube bears very little relation to the current through it.

It can thus be seen that on overloads the current through the tube is limited only by circuit resistance and not by any compensating action of the tube. It is necessary, therefore, to provide overload protection of such nature as to prevent the current through the tube exceeding the published maximum surge current allowable for the particular type of tube.

Mercury vapor tubes are given average current ratings which specify the highest average current that may be carried without damaging the emitter or overheating the parts. Such ratings are always dependent upon certain specified limits of ambient temperature, but this has already been considered under the foregoing suggestions for installation.

Overcurrent protection may be accomplished by the use of high speed overload relays which act to open the primary circuit. Proper protection is obtained when the following relays are employed: (1) Instantaneous overcurrent relays in the primary supply line which, in a three phase system, are placed in two of the three phase leads to insure operation when any one phase of the primary is overloaded, (2) an instantaneous overcurrent relay in the grounded side of the output (D. C.) circuit to operate at an instantaneous value of current below the rated maximum surge current, and (3) a time delay overcurrent relay in the grounded side of the output circuit to operate on continued overload or to protect the tube from passing current in excess of its maximum average current rating for any appreciable period of time.

If in a bank of mercury vapor rectifier tubes, one tube should fail even momentarily, in the inverse direction, the excess current through the other tubes may sputter active cathode material upon the anodes of these tubes, causing some of them to arc back. If the offender can be eliminated immediately, probably no permanent damage will result in the other tubes. This, however, is not always

a simple task without the aid of an arc-back indicator. It is recommended that an arc-back indicator be installed in series with each anode lead to identify the faulty tube in the event that arc-back difficulties are encountered.

For maximum cathode life, rectifier filaments should be maintained at constant rated voltage. This voltage should be maintained at the terminals of the tube. When the rectifier is in operation, the filament circuit is at a high potential above ground, and it is dangerous, therefore, to install a voltmeter at the tube terminals. A third or voltmeter winding on the filament transformer furnishes a means of checking filament voltage and the relationship between the voltage read here with actual tube terminal voltage may be determined at a time when there is no anode voltage applied to the rectifier.

The initial current when starting may be large because of the low "cold resistance" of the filament and the mechanical stress caused by this rush of current may seriously damage the cathode coating. It is advisable to limit this starting current to a value less than 200 per cent of rated current. This may be done by current limiting reactors or resistors which are ultimately shorted out or by the use of special high reactance filament transformers.

The filament starting circuit should be so arranged that the filaments are allowed to rise to full operating temperature before the anode voltage can be applied. Operation at low cathode temperature may seriously damage the active cathode

material. An adjustable time delay relay operating from the filament primary power supply and having a set of contacts in the series with the start circuit of the anode voltage supply will insure proper cathode temperature before the application of anode voltage.

If it is necessary to decrease the heating time to a minimum, the time delay necessary for the particular installation may be determined in the following manner. With the tube in the actual circuit under consideration, a D. C. voltage of at least 45 volts is connected between anode and cathode in series with a resistor sufficient to limit the current to .3 ampere. The anode is connected to the positive terminal of the D. C. voltage source and a voltmeter is connected between anode and cathode. The filament supply switch is closed, and assuming that the tube was cold at the start, the time required for the D. C.

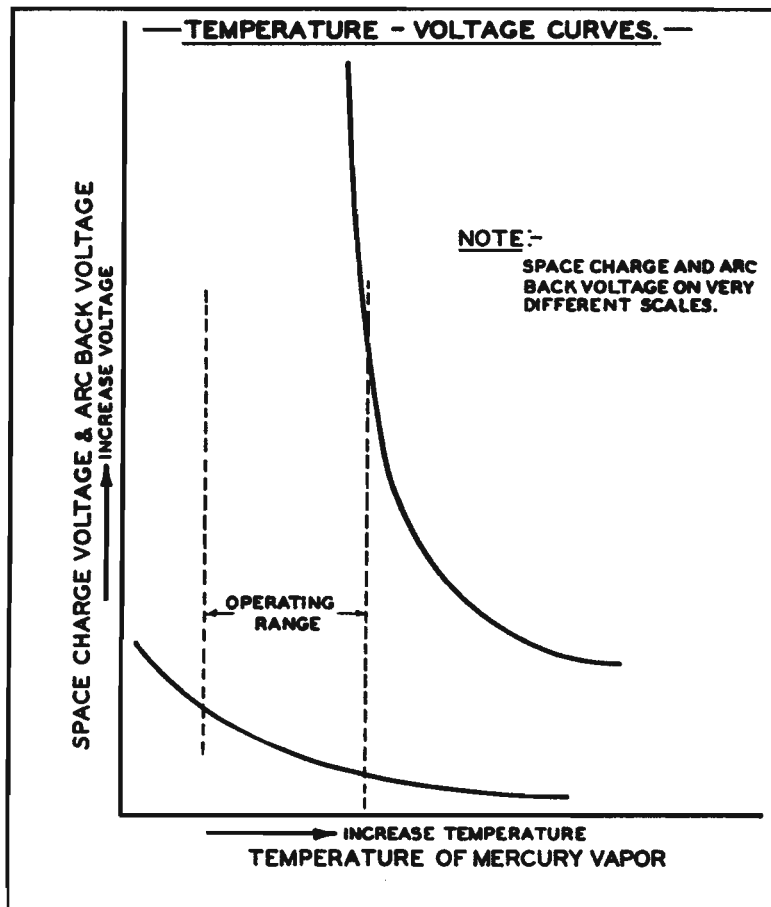

# HANDBOOK OF TUBE OPERATION

---

voltage drop across the tube to reach a constant value is noted. This time is measured for each of the rectifier tubes and the longest time measured is increased by 50 per cent to give the shortest possible delay period permissible for the particular installation.

## OPERATION

In the event of failure of rectifier tubes, it is important, for obvious reasons, that spare tubes be in such condition that they may be placed in operation as quickly as possible.

New tubes as received will probably have deposits of mercury on the active elements because of handling during shipment. These deposits reduce arc-back voltage considerably and the installation of such a tube in a rectifier might cause serious trouble and delay.

The new tube should be given a conditioning treatment after which it should be mounted in a rack in its operating position. If for some reason the tube is later handled in such a manner as to again deposit mercury on the active elements, the treatment should be repeated.

The treatment prescribed in the following paragraph is intended particularly for new tubes which are to be placed

in operation for the first time, but it is suggested that this treatment be applied also to new tubes not placed in immediate service, and that the treatment be repeated every three months on tubes held in storage. The same treatment applies also where a tube has been operated improperly and shows a tendency to arc-back, since its condition may be much improved thereby.

The filament must be lighted at rated voltage for 15 minutes without any applied plate voltage in order to properly distribute the mercury in the tube. The supply voltage should be reduced to give a peak inverse voltage of approximately 4,000 volts, the high voltage primary circuit closed and the rectifier operated for 5 minutes, after which the output potential should be increased gradually during a 15 minute period to obtain the normal operating value.

If the equipment does not permit of this procedure, the full plate voltage should be applied intermittently until the tube operates normally. If the tube gives evidence of flashing, the treating period should be prolonged so that stable operation may be obtained without injury to the tube. Operate the tube under normal conditions for 15 minutes.

# PROPER CARE OF METAL TO GLASS SEALS

## INTRODUCTION

At first thought, it may seem that the subject of metal to glass seals would hold no more than academic interest to the user of vacuum tubes. On the contrary, however, a basic understanding of the nature and limitations of these seals may contribute materially to satisfactory operation.

## HIGH VACUUM SEALS

In transmitting tubes as in all electrical high vacuum devices, some means must be provided to conduct currents and apply potentials to electrodes within the vacuum. Obviously, such conductors must be applied in such manner that they are permanently vacuum tight.

Because of its natural properties, glass is widely used as all or part of the envelope in transmitting tubes and it follows, therefore, that it must become necessary to devise means of passing metallic conductors through or sealing metal parts to glass.

The art of sealing metal to glass is not new. Long before any scientific data upon expansion coefficients and surface "wetting" characteristics was made available, skilled glass workers were able to make devices involving glass and metal sealed together. It may be said even today that the working of glass and metal together is more of an art than a science. Perhaps it should be added that the greater part of the scientific data on this subject available today was derived from studies of technique that had proved successful before all the principles involved were thoroughly understood.

## ADHESION

The fundamental requirement of a metal to glass seal is that the glass must "wet" the metal. Putting it another way, the glass must flow out in a thin adherent sheet rather than collect in a globule. In the strictest sense, glass will not "wet" a pure clean metal surface. If the surface is oxidized, however, the glass will "wet" it and form a seal.

One of the first successful glass to metal seals was made with platinum. It was believed that platinum would seal to certain glasses without the aid of an oxidized surface. Present day knowledge, however, leads to the belief that the seal is the result of the presence of a very stable layer of oxide on the surface of the platinum.

It should be pointed out here that merely to oxidize the surface of the metal is by no means the only requirement to make the glass "wet" it and form a seal. The oxide must be correct chemically (most metals have several oxides) while physically it must be in the form of a thin, smooth, adherent layer.

Thus we arrive at the true nature of a metal to glass seal. The glass adheres to the oxide by dissolving a portion of its surface and the oxide in turn adheres to the metal by the nature of that particular oxide and its method of formation. Consequently, the metal oxide provides a cement bond between the metal and the glass and this principle applies to all classes of seals.

## EXPANSION

Having provided the bond there remains the problem of providing for expansion and contraction. This leads to a division into two major classifications, namely, (1) seals in which the materials have similar coefficients of expansion, (2) seals in which flexibility is provided in the metal to allow for a differential in the expansion coefficients.

Common examples of the first group are the lead-in wires used in lamps and vacuum tubes brought in through presses or button seals. In the second type are found the familiar copper to glass seal used for anodes in water cooled tubes and in some cases grid and filament leads as well.

Under the first classification the seal most generally used in transmitting tubes is made between tungsten and "hard glass". Among the "hard glass" formulas there are several which will seal to tungsten. The expansion curves of some of these are shown in Fig. 1. It will be noted that they all have one common characteristic—the coefficient of expansion changes with rising temperature causing the line to curve upward. As the expansion curve for pure metals is nearly a straight line, obviously the requirement of identical coefficient of expansion is impossible to attain. Nevertheless, practical seals can be made if the difference in expansion does not create a stress greater than the tensile strength of either the glass or the bond. This compromise places limitations on the size of tungsten that can be sealed through glass. Tungsten rod up to 0.125 in. in diameter can be used commercially without special technique and up to 0.250 in. in diameter when special precautions are observed. Sizes in excess of 0.250 in., however, would not be considered commercially successful.

## TEMPERATURE

Further examination of Fig. 1, discloses that at the higher temperatures the curves diverge sharply. Where this divergence becomes marked, excessive strains are set up which will cause rupture of the seals, thereby placing an additional limitation on the use of such seals. In other words, there is an upper temperature limit which must not be exceeded.

This upper temperature limit is not imposed by mechanical stresses alone. The bond between the glass and tungsten will be destroyed if maintained at high temperatures for long periods of time.

Fortunately, most applications do not require temperatures above the safe limit or it is possible to so design the entire device that the seals are located in comparatively cool areas. With the increased use of larger transmitting tubes and more stringent service required by them it

# HANDBOOK OF TUBE OPERATION

Fig. 1. THERMAL EXPANSION OF SELECTED METALS AND GLASS.

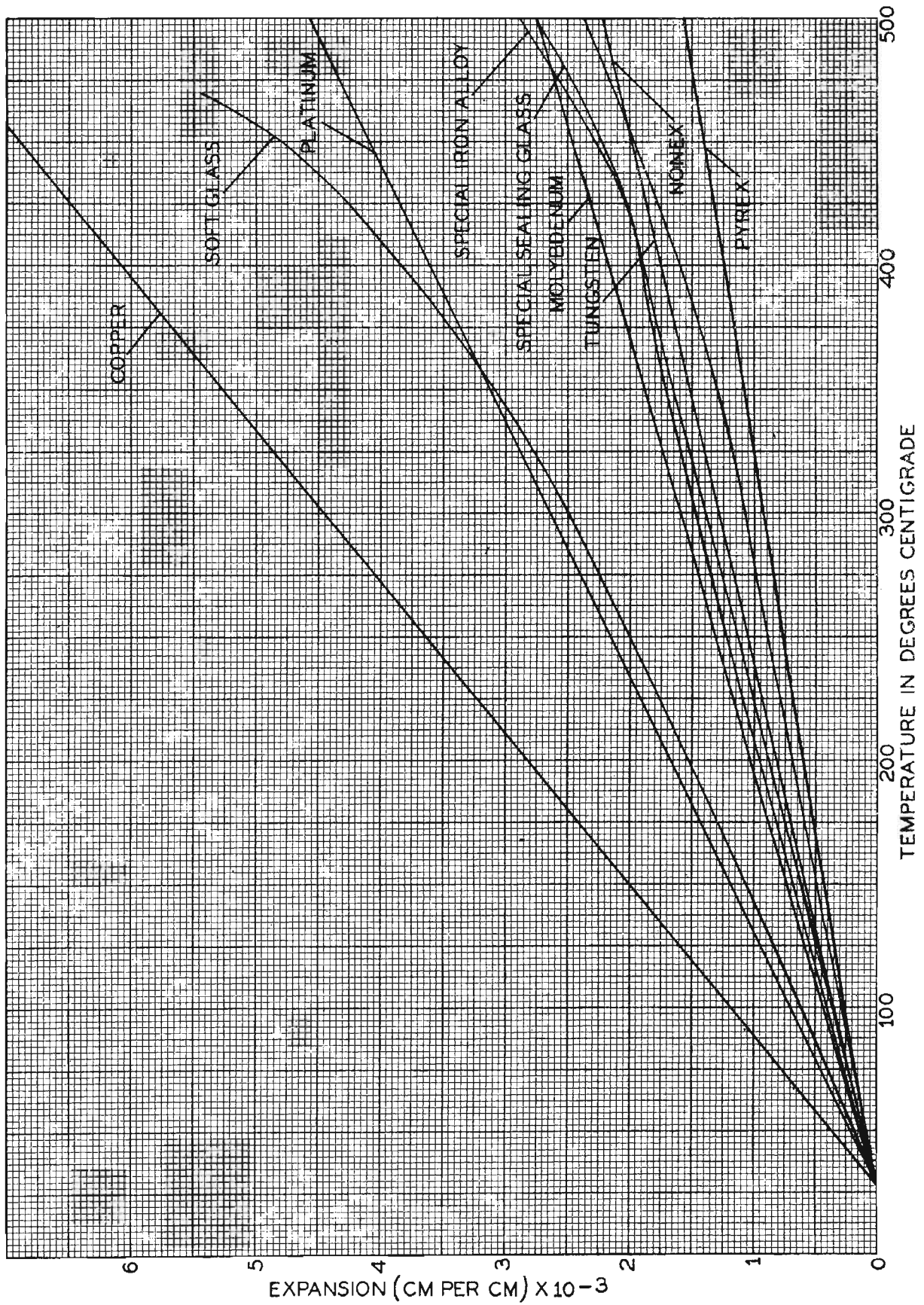

sometimes proves necessary or advisable to provide artificial cooling.

## ARTIFICIAL COOLING

There are several precautions which should be observed when artificial cooling is used. Care must be exercised, for instance, to make certain that the glass is not chilled or cooled unevenly. In Fig. 2, is shown a method of cooling the stem of a water cooled tube. Since the source of the heat is within the tube and the heat is applied to the inside surfaces by radiation and conduction along the lead wires, it is obvious that a high temperature gradient may be created if excessive cooling is applied.

Glass is a relatively poor conductor of heat. If too much cooling is applied, therefore, in the upper glass portions of the tube a strain will be set up in the region designated by "x". In order to avoid this possibility it is necessary to keep the air blast between certain limits. If the arrangement of Fig. 2, is used, the air blast to be effective should be at least three cubic feet of free air per minute and should not exceed seven cubic feet per minute. These limits are based upon delivery through a tube or hose with a one-quarter inch inside diameter. A jet should not be used.

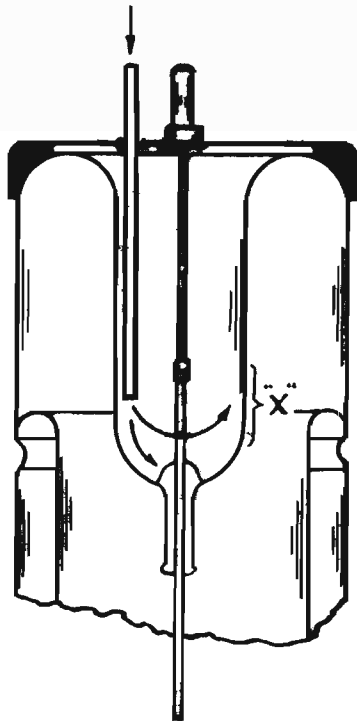

Fig. 2. Method of Air Cooling Filament Seal.

Conceivably, the question may arise as to when air cooling is advisable. To a great extent this will depend upon the individual installation. If there is any evidence of destruction of the bond between the glass and metal, cooling is, of course, advisable. Destruction of the bond may be detected by examination of the lead wires through the glass. Deterioration is indicated by the change from the gold or bronze color to a dull, sooty black.

## ALLOY SEALS

Within the past few years developments have taken place in the use of alloy metals having a marked curvature in their expansion characteristics. (See Fig. 1.) This curvature matches that of certain glasses very closely, thus practically eliminating the problem of differential expansion. Bonding technique and limitations in this case are similar to those which apply to tungsten.

## COPPER TO GLASS SEALS

Glancing again at Fig. 1, it becomes apparent that the expansion coefficient of copper differs so widely from that of glass that rupture would be certain unless some flexibility were provided. The high ductility and low yield point of copper make it possible to fulfill the condition that stresses from expansion and contraction must not exceed the tensile strength of the glass.

This is true only if the copper is moderately thin where it comes in contact with the glass. The thin copper required results in a certain amount of mechanical weakness and while the copper seals used in transmitting tubes today are sufficiently rugged to withstand normal handling and usage, they may still be said to be the weakest point on the exterior of the tube.

In order to make a successful copper glass seal the copper must be specially selected. The "oxygen free" or "deoxidized" forms are the best suited for this purpose.

Small quantities of oxygen in copper tend to modify the crystal structure of the metal in such a manner as to materially reduce its ductility. As the permanence of the seal is dependent upon the yielding of the copper during expansion and contraction of temperature cycles, it is obvious that its ductility should be maintained as long as possible.

Copper that is not free from oxygen will rapidly become brittle and tend to fracture when subjected to repeated deformations.

In addition to the mechanical effect of temperature cycles on copper seals, sustained high temperatures will tend to destroy the bond. Fortunately, there is a visible indication of excessive temperature. The seal will change color. As excessive temperatures are approached the normal red color will become greenish, progressing to a sooty black. The greenish stage may represent the safe limit of operation. This applies particularly to internal seals which are not required to hold vacuum.

Generally speaking, external seals should not be operated at temperatures such that any change of color is noticeable. If such conditions should be unavoidable an air blast similar to that described above is advisable.

Little concern need be given to the temperature of the common copper glass seal between the envelope and anode of water cooled tubes. Here the thermal conductivity of the copper is sufficient to keep the seal at a safe temperature when adequate cooling is applied to the anode.

# Index

Longer Tube Life.....	5
Secondary Emission in Transmitting Tubes.....	7
Why Maximum Ratings for Transmitting Tubes.....	10
Typical Operation Data Including Methods of Calculation.....	13
Tube Protection Problems (Part One).....	16
Tube Protection Problems (Part Two).....	19
Graphical Methods of Harmonic Analysis.....	22
Calculation of Class C Plate Modulated RF Power Amplifiers.....	25
Calculation of Class B Radio Frequency Power Amplifiers.....	28
The Doherty High-Efficiency Amplifier.....	31
More About the Doherty High-Efficiency Amplifier.....	33
Filament Heating Transients.....	36
Multi-Phase Filaments .....	39
Forced-Air Cooled Tubes.....	42
Graphical Design of Frequency Multiplier Amplifiers (Part One).....	45
Graphical Design of Frequency Multiplier Amplifiers (Part Two).....	48
Grid-Bias Modulated RF Amplifiers.....	51
Federal Develops Tube to Meet Wide Service Range.....	54
Essential Elements in Transmitting Tubes.....	57
Technical Tube Data and What It Means.....	59
Care and Operation of Mercury Vapor Rectifier Tubes.....	62
Proper Care of Metal to Glass Seals.....	65



